

Panasonic®

■ This product is eligible for the AVCCAM 3 Year Warranty Repair Program. For details, see page 5.

Operating Instructions

Memory Card Camera-Recorder

Model No. **AG-HMC40P**

AVCCAM

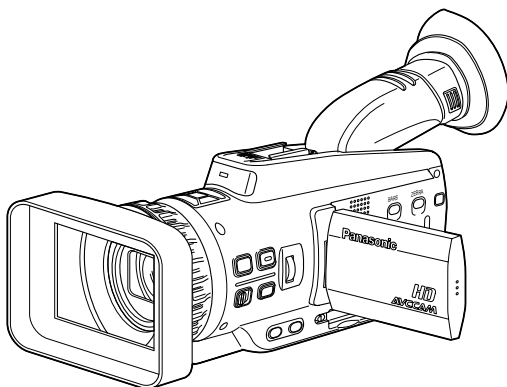

Before operating this product, please read the instructions carefully and save this manual for future use.

ENGLISH

Before use
Description of parts
Preparation
Shooting
Playback
Editing
Displays
Menu
Reference

Read this first!

 indicates safety information.



CAUTION
RISK OF ELECTRIC SHOCK
DO NOT OPEN



CAUTION: TO REDUCE THE RISK OF ELECTRIC SHOCK, DO NOT REMOVE COVER (OR BACK). NO USER-SERVICEABLE PARTS INSIDE. REFER TO SERVICING TO QUALIFIED SERVICE PERSONNEL.



The lightning flash with arrowhead symbol, within an equilateral triangle, is intended to alert the user to the presence of uninsulated "dangerous voltage" within the product's enclosure that may be of sufficient magnitude to constitute a risk of electric shock to persons.



The exclamation point within an equilateral triangle is intended to alert the user to the presence of important operating and maintenance (servicing) instructions in the literature accompanying the appliance.

WARNING:

- TO REDUCE THE RISK OF FIRE OR SHOCK HAZARD, DO NOT EXPOSE THIS EQUIPMENT TO RAIN OR MOISTURE.
- TO REDUCE THE RISK OF FIRE OR SHOCK HAZARD, KEEP THIS EQUIPMENT AWAY FROM ALL LIQUIDS. USE AND STORE ONLY IN LOCATIONS WHICH ARE NOT EXPOSED TO THE RISK OF DRIPPING OR SPLASHING LIQUIDS, AND DO NOT PLACE ANY LIQUID CONTAINERS ON TOP OF THE EQUIPMENT.

WARNING:

Always keep memory cards (optional accessory) or accessories (coin battery, PIN-BNC conversion plugs, ferrite cores, cable ties, XLR connector cap) out of the reach of babies and small children.

CAUTION:

TO REDUCE THE RISK OF FIRE OR SHOCK HAZARD AND ANNOYING INTERFERENCE, USE THE RECOMMENDED ACCESSORIES ONLY.

CAUTION:

Do not jar, swing, or shake the unit by its handle while the conversion lens or another accessory is attached. Due to the added weight of the conversion lens, any strong jolt to the handle may damage the unit or result in personal injury.

CAUTION:

THE MAINS PLUG OF THE POWER SUPPLY CORD SHALL REMAIN READILY OPERABLE. THE AC RECEPTACLE (MAINS SOCKET OUTLET) SHALL BE INSTALLED NEAR THE EQUIPMENT AND SHALL BE EASILY ACCESSIBLE. TO COMPLETELY DISCONNECT THIS EQUIPMENT FROM THE AC MAINS, DISCONNECT THE POWER CORD PLUG FROM THE AC RECEPTACLE.

CAUTION:

- Danger of explosion or fire if battery is mistreated.
- Do not leave the battery in an automobile exposed to direct sunlight for a long period of time with doors and windows closed.
- Do not disassemble the battery or dispose of it in fire.
- Do not store in temperatures over 60°C (140°F).

For Battery Pack

- Use specified charger.
- Replace only with same or specified type.

For Battery of Remote Controller

- Replace battery with part No. CR2025 only.
- Do not recharge the battery.

CAUTION:

In order to maintain adequate ventilation, do not install or place this unit in a bookcase, built-in cabinet or any other confined space. To prevent risk of electric shock or fire hazard due to overheating, ensure that curtains and any other materials do not obstruct the ventilation.

CAUTION:

Do not lift the unit by its handle while the tripod is attached. When the tripod is attached, its weight will also affect the unit's handle, possibly causing the handle to break and hurting the user. To carry the unit while the tripod is attached, take hold of the tripod.

CAUTION:

EXCESSIVE SOUND PRESSURE FROM EARPHONES AND HEADPHONES CAN CAUSE HEARING LOSS.

CAUTION:

Do not leave the unit in direct contact with the skin for long periods of time when in use. Low temperature burn injuries may be suffered if the high temperature parts of this unit are in direct contact with the skin for long periods of time. When using the equipment for long periods of time, make use of the tripod.

Note:

Camera-Recorder

The rating plate is on the underside of the camera recorder.

AC Adapter

The rating plate is on the underside of the AC Adapter. Disconnect the AC mains plug from the AC mains socket when not in use.

FCC NOTICE (USA)

Declaration of Conformity

Model Number: AG-HMC40P

Trade Name: Panasonic

Responsible Party: Panasonic Corporation of North America One Panasonic Way, Secaucus, NJ 07094

Support contact: Panasonic Broadcast & Television Systems Company 1-800-524-1448

This device complies with Part 15 of the FCC Rules.

Operation is subject to the following two conditions:

(1) This device may not cause harmful interference, and (2) this device must accept any interference received, including interference that may cause undesired operation.

To assure continued compliance, follow the attached installation instructions and do not make any unauthorized modifications.

CAUTION:

This equipment has been tested and found to comply with the limits for a Class B digital device, pursuant to Part 15 of the FCC Rules. These limits are designed to provide reasonable protection against harmful interference in a residential installation. This equipment generates, uses and can radiate radio frequency energy and, if not installed and used in accordance with the instructions, may cause harmful interference to radio communications. However, there is no guarantee that interference will not occur in a particular installation. If this equipment does cause harmful interference to radio or television reception, which can be determined by turning the equipment off and on, the user is encouraged to try to correct the interference by one of the following measures:

- Reorient or relocate the receiving antenna.
- Increase the separation between the equipment and receiver.
- Connect the equipment into an outlet on a circuit different from that to which the receiver is connected.
- Consult the dealer or an experienced radio/TV technician for help.

The user may find the booklet "Something About Interference" available from FCC local regional offices helpful.

FCC Warning:

To assure continued FCC emission limit compliance, follow the attached installation instructions and the user must use only shielded interface cables when connecting to host computer or peripheral devices. Also any unauthorized changes or modifications to this equipment could void the user's authority to operate this device.

NOTIFICATION (Canada)

This class B digital apparatus complies with Canadian ICES-003.



A lithium ion/polymer battery that is recyclable powers the product you have purchased. Please call 1-800-8-BATTERY for information on how to recycle this battery.

For USA-California Only

This product contains a CR Coin Cell Lithium Battery which contains Perchlorate Material – special handling may apply.

See www.dtsc.ca.gov/hazardouswaste/perchlorate.

IMPORTANT SAFETY INSTRUCTIONS

- 1) Read these instructions.
- 2) Keep these instructions.
- 3) Heed all warnings.
- 4) Follow all instructions.
- 5) Do not use this apparatus near water.
- 6) Clean only with dry cloth.
- 7) Do not block any ventilation openings. Install in accordance with the manufacturer's instructions.
- 8) Do not install near any heat sources such as radiators, heat registers, stoves, or other apparatus (including amplifiers) that produce heat.
- 9) Do not defeat the safety purpose of the polarized or grounding-type plug. A polarized plug has two blades with one wider than the other. A grounding-type plug has two blades and a third grounding prong. The wide blade or the third prong are provided for your safety. If the provided plug does not fit into your outlet, consult an electrician for replacement of the obsolete outlet.
- 10) Protect the power cord from being walked on or pinched particularly at plugs, convenience receptacles, and the point where they exit from the apparatus.
- 11) Only use attachments/accessories specified by the manufacturer.
- 12) Use only with the cart, stand, tripod, bracket, or table specified by the manufacturer, or sold with the apparatus. When a cart is used, use caution when moving the cart/apparatus combination to avoid injury from tip-over.
- 13) Unplug this apparatus during lightning storms or when unused for long periods of time.
- 14) Refer all servicing to qualified service personnel. Servicing is required when the apparatus has been damaged in any way, such as power-supply cord or plug is damaged, liquid has been spilled or objects have fallen into the apparatus, the apparatus has been exposed to rain or moisture, does not operate normally, or has been dropped.



Recommendation for Use of Genuine Panasonic Battery (Rechargeable Battery)

Thank you for using a Panasonic product.

It has been found that counterfeit battery packs which look very similar to the genuine product are made available to purchase in some markets. Some of these battery packs are not adequately protected with internal protection to meet the requirements of appropriate safety standards. There is a possibility that these battery packs may lead to fire or explosion. Please be advised that we are not liable for any accident or failure occurring as a result of use of a counterfeit battery pack. To ensure that safe products are used we would recommend that a genuine Panasonic battery pack is used.

- Be aware that many batteries sold at extremely cheap prices or in situations where it is difficult to verify the actual products before purchase have proven to be counterfeit.

■ Batteries that may be used with this product (Correct as of August 2009)

Panasonic VW-VBG130, VW-VBG260 and VW-VBG6 batteries may be used with this product.

The VW-VBG130, VW-VBG260 and VW-VBG6 batteries contain a function to enable verification as to whether they may be safely used with this product.

AVCCAM 3 Year Warranty Repair Program*1

Thank you for purchasing this Panasonic AVCCAM device.

Register as a user for this device to receive a special service warranty up to three years of free warranty repairs.

Customers who register as users on the website will receive an extended warranty repair valid for up to three years.



	1 st year	2 nd year	3 rd year
AVCCAM device*2	Basic warranty*3	Extended warranty repair*4	

*1: Please note that this extended warranty is not available in some countries/regions. *2: Not all models eligible for extended warranty coverage.
*3: The basic warranty period may vary depending on the country/region. *4: Not all repair work is covered by this extended warranty.



Purchase AVCCAM product



Register online within 1 month



"Registration Notice" e-mail sent

Free 3 years of Warranty Repairs

Make sure to save the "Registration Notice" e-mail during the warranty period.

Details about user registration and the extended warranty: http://panasonic.biz/sav/pass_e
Please note, this is a site that is not maintained by Panasonic Canada Inc. The Panasonic Canada Inc. privacy policy does not apply and is not applicable in relation to any information submitted. This link is provided to you for convenience.

-
- The SDHC logo is a trademark.
 - The miniSD logo is a trademark.
 - “AVCHD” and the “AVCHD” logo are trademarks of Panasonic Corporation and Sony Corporation.
 - This product has been manufactured under license from Dolby Laboratories.
Dolby and the double-D symbol are trademarks of Dolby Laboratories.
 - HDMI, the HDMI logo, and High-Definition Multimedia Interface are trademarks or registered trademarks of HDMI Licensing LLC.
 - LEICA is a registered trademark of Leica Microsystems IR GmbH.
 - DICOMAR is a registered trademark of Leica Camera AG.
 - Microsoft®, Windows®, and Windows Vista® are either registered trademarks or trademarks of Microsoft Corporation in the United States and/or other countries.
 - Screenshots are used in accordance with Microsoft Corporation guidelines.
 - IBM and PC/AT are registered trademarks of International Business Machines Corporation.
 - Intel® is a registered trademark or a trademark of Intel Corporation in the United States and/or other countries.
 - Macintosh® is a trademark of Apple Inc., registered in the United States and other countries.
 - Other model names, company names, and product names listed in these operating instructions are trademarks or registered trademarks of their respective companies.
 - This product is licensed under the AVC Patent Portfolio License for the personal and non-commercial use of a consumer, and no license is granted or shall be implied for any use other than the personal uses detailed below.
 - To encode video in compliance with the AVC standard (“AVC Video”)
 - To decode AVC Video that was encoded by a consumer engaged in a personal and non-commercial activity
 - To decode AVC Video that was obtained from a video provider licensed to provide AVC Video
 - Additional information may be obtained from MPEG LA, LLC (<http://www.mpegla.com>).
 - Separate license contracts must be obtained from MPEG LA where SD Memory Cards containing information recorded with this product are to be distributed to end users for commercial purposes. “End user” refers to persons or organizations handling such contents for personal use.

Note concerning illustrations in these instructions

- Illustrations (camera-recorder, menu screens, etc.) in these operating instructions differ slightly from the actual camera-recorder.

References

- References are shown as (Page 00).

Terminology

- Both SD Memory Cards and SDHC Memory Cards as referred to as “SD Memory Cards” in these operating instructions.
- Video that is created during a single recording operation is referred to as a “clip” in these operating instructions.

Contents

Read this first!	2
IMPORTANT SAFETY INSTRUCTIONS	4

Before use

Operating precautions	9
Precaution for use	11
SD Memory Cards compatible with this product.....	12
CLASS 4 (SD speed class 4).....	13
SDHC Memory Cards.....	13
Compatibility of recorded video	14
About AVCHD	14
Accessories	15
Optional accessories	16
Using tele conversion lenses, wide conversion lenses	16

Description of parts

Description of parts.....	17
Right side and rear side	17
Left side.....	18
Terminals and mounting parts	19
Remote control	20

Preparation

Recharging the battery	21
Recharging	21
Power sources	23
Using the battery	23
Using the AC adapter	23
Adjusting the hand strap	24
Attaching the shoulder strap.....	24
Detaching and attaching the lens hood	24
Attaching the handle	25
Fitting the eye cup	25
The remote control	26
Insert the battery	26
Remote control usable range	26
Turn on/off the camera	26
Quick Start mode.....	27
Tally lamp	27
Touch panel.....	28
Using the touch panel.....	28
Viewfinder	29
Using the viewfinder	29
Using the LCD	30
Emphasizing outlines	30
Adjusting the screen display.....	31
Adjusting the touch panel	31
Setting the calendar	32
Setting the time zone.....	32
Setting the clock	32

Shooting

Basic shooting operations	33
Preparing for recording.....	33
SD Memory Card ACCESS lamp	33
Shooting in auto mode	34
Checking photos taken (REC CHECK)	35
Formatting SD Memory Cards.....	35
SD Memory Card recording times	36
Removing SD Memory Card	37
Protecting SD Memory Cards.....	37
Repairing SD Memory Cards	37
Using the zoom function.....	38
Digital zoom function	38
Shooting in progressive mode.....	39
Shooting in manual mode.....	40
Switching to manual mode	40
Manual focusing	40
Using focus assist	41
Setting the aperture and gain	41
Adjusting the white balance and black balance	42
Shooting techniques for different targets..	44
Touch auto focus (CAMERA mode only)	44
Self-portrait shooting	44
Zebra pattern	45
Marker	45
Checking and displaying shooting status	45
PRE REC	46
Optical Image Stabilizer	46
Adding effects to images	46
Using the USER buttons	46
Backlight compensation	47
Color bars.....	47
Wave form monitor function.....	47
Adjusting the headphone volume while shooting.....	47
Shot mark function	47
Interval recording	48
Time stamp function	49
LAST CLIP function	49
Adjusting the shutter speed.....	50
Synchro scan	52
Adjusting the mic input level.....	53
Using scene files	54
Loading scene files	54
Setting and saving scene files	54
Initializing scene files	55
Clip metadata	56
Loading the metadata.....	57
Selecting the USER CLIP NAME recording method	57
Using the Counter	58
Counter display	58
Charging the built-in battery/ Setting the time code	59
Recharging the built-in battery	59
Setting the time code.....	59

Contents (continued)

Specifying the time code	59
Setting user information	60
Shooting photos	61
Setting the aspect ratio / recording pixels	62
Setting the picture quality	62
Maximum number of photos	63

Playback

Thumbnail screen	65
During clip playback	65
During photo playback	66
Thumbnail operations	67
Selecting the thumbnail display method	67
Format card and card information	68
Confirming clip information	69
Adding a SHOT MARK to a clip	69
Playing back clips	70
Clip playback settings	73
Set playback format	73
Repeat playback	73
Resume playback (RESUME PLAY)	73
Playing back photos	74
Playback by date	75
Useful playback functions	76
Adjust volume (remote control)	76
Viewing images on a television	76
Checking the date and time	76
Deleting clips/photos (videos and photos)	77
Deleting multiple clips or photos simultaneously	77
Selecting clips or photos to delete	77
Setting protection (videos and photos)	78
Protecting clips	78
Protecting photos	78
DPOF settings (photos)	79
Printing photos on a printer (PictBridge)	80

Editing

Connecting external units	82
Headphones	82
External microphone (Stereo mini jack compatible)	82
External microphone (XLR Microphone Adapter (optional) compatible)	82
Computer (non-linear editing/file transfer)	83
Video deck (Dubbing)	83
TV/Monitor	84
Nonlinear editing	85

Displays

Screen displays	86
Regular displays	86
Main warning displays	91
Setting the DISPLAY items	93

Menu

Using the setup menus	95
Using the menus	95
Using Quick Menu and Function Navi	96
Initializing the menu settings	97
Setup menu structure	98
CAMERA mode menu	98
PHOTO mode menu	98
PB mode menu	99
Setup menu list	100
SCENE FILE screen	100
CAMERA SETUP screen	101
RECORD SETUP screen	102
PICTURE screen	104
PLAY SETUP screen	105
OPERATION screen	105
PICT. SETUP screen	105
SW&DISP SETUP screen	106
OTHER FUNCTIONS screen	109

Reference

Before calling for service	112
Updating the firmware	116
Cleaning	116
Storage Precautions	117
Recording format	118
How to handle data recorded on SD Memory Card	119
Specifications	120

Operating precautions

Do not allow any water to get into the camera-recorder when using it in the rain or snow or at the beach.

- Failure to heed this caution will cause the camera-recorder or a card to malfunction (and may result in irreparable damage).

Keep the camera-recorder away from equipment (such as TV sets and video game machines) that generate magnetic fields.

- Using the camera-recorder on top of or near a TV set may cause distortion in the images and/or sound due to the electromagnetic waves that the set emits.
- The powerful magnetic fields generated by speakers or large motors may damage your recordings or distort the images.
- The electromagnetic waves emitted from a microcomputer will adversely affect the camera-recorder, causing the images and/or sound to be distorted.
- If the camera-recorder is so adversely affected by products that generate magnetic fields that it no longer operates properly, turn it off and remove the battery or unplug the AC adapter from the power outlet. Then install the battery again or reconnect the AC adapter. After this, turn the camera-recorder back on.

Do not use the camera-recorder near radio transmitters or high-voltage equipment.

- Using the camera-recorder near a radio transmitter or high-voltage equipment may adversely affect the recorded images and/or sound.

Do not allow any sand or dust to get into the camera-recorder when using it at the beach and other similar places.

- Sand and dust can damage the camera-recorder or a card. (Be especially careful when inserting or removing a card.)

AC adapter and battery

- If the CHARGE lamp continues to blink even when the battery temperature is normal, there may be something wrong with the battery or AC adapter. Contact your dealer.
- The battery takes longer to charge when it is warm.
- The AC adapter can interfere with radio reception so keep radios at least 1 meter away from it.

- The AC adapter may make some noise when you are using it, but this is normal.

Take precautions not to drop the camera when moving it.

- Strong impacts may damage the camera and cause it to stop working.
- Handle the camera with care, using the hand strap or shoulder strap to carry it.

Do not spray the camera with insect sprays or other volatile substances.

- These can warp the camera or cause the finish to come off.
- Do not leave the camera-recorder in contact with rubber or PVC products for extended periods of time.

After use, remove the battery and disconnect the AC power supply cable.

Battery characteristics

This camera-recorder uses a rechargeable lithiumion battery that uses its internal chemical reaction to generate electrical energy. This reaction is easily influenced by the ambient temperature and humidity, and the battery's effective operating time is reduced as the temperature rises or falls. In very low temperatures, the battery may last only 5 minutes.

Protective circuitry functions if you use the battery where it is very hot and you will have to wait before you can use it again.

Remove the battery after use.

Completely remove the battery. (The battery continues to be used even if you have turned the camera off.) The battery can over discharge if you leave it in the camera and it may become impossible to recharge it.

Disposing of spent batteries

The battery will become unchargeable. Rather than throwing the battery into the garbage, take it to a store that can assist in recycling it.

(Continued on the next page)

Operating precautions (continued)

What to remember when throwing memory cards away or transferring them to others

Formatting memory cards or deleting data using the functions of the unit or a computer will merely change the file management information: it will not completely erase the data on the cards. When throwing these cards away or transferring them to others, either physically destroy them or use a data deletion program for computers (commercially available) to completely erase the data. Users are responsible for managing the data on their memory cards.

Liquid crystal displays

- Images or letters can get burned onto the screen of the LCD or viewfinder if they are displayed for a long time, but you can fix this by leaving the camera off for several hours.
- The liquid crystal parts are highly precise with 99.99% of the pixels effective. This leaves less than 0.01% of pixels that may not light or may remain on all the time. These phenomena are normal and will have no effect on the images you shoot.
- Condensation may form if you use the camera where temperatures fluctuate. Wipe dry with a soft, dry cloth.
- The LCD may appear dim after immediately turning on a cold camera, but will brighten as the camera warms up.

Do not point the lens or viewfinder at the sun.

Doing so may damage the parts inside.

Protective caps for the connectors

Keep the protective caps fitted over any connectors that are not being used.

Precaution for use

Always take some trial shots before actual shooting.

- When shooting important events (such as weddings), always take some trial shots and check that the sound and images have been recorded properly before actual shooting.

Be sure to check and set the calendar and time zone.

- These settings affect the control and playback sequence of the recorded contents. Before making a recording, set and check the calendar and time zone. (Page 32)

Panasonic makes no guarantees for your recordings.

- Please understand that Panasonic makes no guarantees for your recordings in cases where images and/or sound were not recorded as you intended due to problems with the camera-recorder or SD/SDHC Memory Cards.

Respect copyrights

- Copyright laws forbid the use of video and audio material you have recorded for any purpose other than your own personal enjoyment. Remember that restrictions apply to the shooting of certain material even if it is intended for private use.

Media that can be used in this unit

- SD/SDHC Memory Cards can be used in this unit. For details, refer to page 12.

Mounting the camera-recorder on a tripod

- The tripod mounting hole is 5.5 mm deep. Do not force the tripod screw beyond this depth. You can damage the camera-recorder if you use any screw other than 1/4-20UNC.

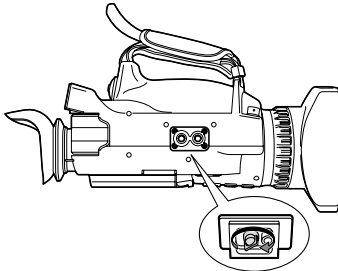

Attach the tripod to the tripod hole.
For other usage notes, see page 9.

Precaution for use (continued)

SD Memory Cards compatible with this product

It is recommended that you use SD Memory Cards or SDHC Memory Cards* of SD speed class 2 or above, or the following Panasonic SD Memory Cards (correct as of August 2009).

* Speed class 4 or above is required for recording in PH mode or HA mode.

Card type	Recording capacity	Recording/playback	Photo shooting Loading metadata
SD Memory Card	8 MB 16 MB	Cannot be used.	Can be used.
	32 MB 64 MB 128 MB 256 MB	Successful operation cannot be guaranteed. Recording may be suddenly terminated with certain SD Memory Cards.	
	512 MB	RP-SDV512	
	1 GB	RP-SDV01G RP-SDM01G	
	2 GB	RP-SDV02G RP-SDM02G RP-SDP02G	
	SDHC Memory Card	4 GB	
6 GB		RP-SDM06G	
8 GB		RP-SDV08G RP-SDM08G RP-SDW08G RP-SDP08G	
12 GB		RP-SDM12G RP-SDP12G	
16 GB		RP-SDV16G RP-SDM16G RP-SDW16G RP-SDP16G	
32 GB		RP-SDV32G RP-SDW32G	

- Please see our support page at the following website for the latest information not included in these operating instructions.
<https://www.pavc.panasonic.co.jp/pro-av/>
- This product is compatible with SD Memory Cards formatted under the SD-standard FAT12 and FAT16 formats, and with SDHC Memory Cards formatted under the FAT32 format.
- Only SDHC Memory Cards may be used for capacities of 4 GB or greater.
- 4 GB (or greater) memory cards without the SDHC logo are not based on the SD standard.
- Use this product to format the SD Memory Cards to be used. Formatting memory cards on computers or other devices may cause recording to take longer than normal, or may cause cards to become incompatible with this product. (Page 36) (Use this product to reformat any cards that have already been formatted on computers, etc.)
- Always install the relevant special adapter when using miniSD/miniSDHC cards with this product. (The product will not operate correctly if only the adapter is inserted – always insert a memory card into the adapter first.)
- MultiMediaCards cannot be used with this product.

This product (SDHC-compatible device) is compatible both with SD Memory Cards and with SDHC Memory Cards. SDHC Memory Cards may be used with SDHC Memory Card-compatible devices, but cannot be used with devices that are only compatible with SD Memory Cards. (Always check the relevant product's operating instructions when using SDHC Memory Cards with other devices.)

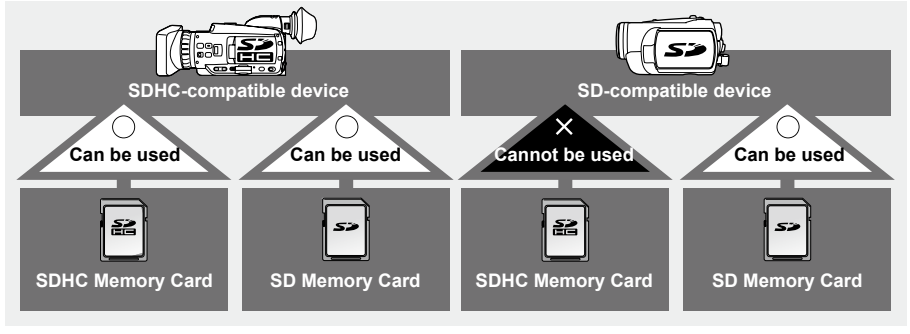

CLASS 4 (SD speed class 4)

This refers to a class 4 speed standard (SD speed class) for the continuous writing of data between SD-compatible devices and SD Memory Cards, as designated by the SD standards.

When the use of an SD speed class 4 card is recommended for SD-compatible products, this indicates that stable recording operation can be achieved when using SD Memory Cards of class 4 and above.

Cautions for usage

- Do not allow dirt, water, or other substances to come into contact with the connector part on the reverse of the card.
- Do not leave the card in the following places:
 - In direct sunlight or in places of high humidity, e.g. close to heating equipment
 - In highly humid or dusty locations
 - In locations with high variations in temperature (condensation may appear on card)
 - In places subject to static electricity or electromagnetic waves
- Store cards in bags or cases after use.

SDHC Memory Cards

- SDHC Memory Cards cannot be used with non-SDHC-compatible equipment.
- Ensure that all equipment is SDHC-compatible when using card with other devices.



Precaution for use (continued)

Compatibility of recorded video

- Recorded video cannot be used with non-AVCHD-compatible equipment. For details, please see your product's operating instructions.
- Recorded video cannot be played back on non-compatible (non-AVCHD-compatible) equipment.
- Playback may not always be possible on all AVCHD-compatible equipment. Please use this product for playback in such instances.

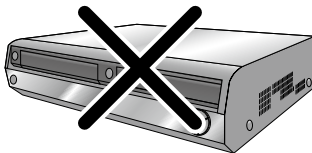













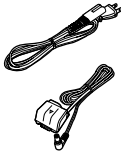
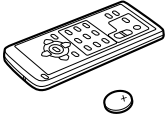

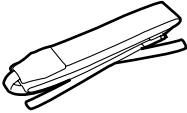
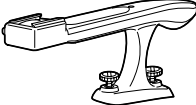

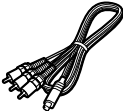
**Older, non-AVCHD-compatible
DVD recorder or DVD player, etc.**

About AVCHD

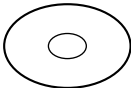
- AVCHD is a standard for the recording and playback of highly detailed, high-definition video.
- Video is compressed in the MPEG-4 AVC/H.264 formats, and audio is recorded in Dolby Digital.

Accessories

Before use

<p>Battery*1</p> 	<p>AC Adapter</p> 	<p>AC power supply cables/ DC cable</p> 	<p>Wireless remote control and battery (CR2025)</p> 		
<p>Eye cup</p>  <p>→ See "Fitting the eye cup". (Page 25)</p>	<p>Shoulder strap</p>  <p>→ See "Attaching the shoulder strap". (Page 24)</p>	<p>Handle</p>  <p>→ See "Attaching the handle". (Page 25)</p>	<p>AV cable</p> 		
<p>Component video cable</p> 	<p>PIN-BNC conversion plugs (3)</p> 	<p>Ferrite core (4)*2</p> 	<p>Touch pen</p> 		
<p>Cable ties (4)</p>  <p>→ See "Attaching cable ties". (Page 84)</p>	<p>CD-ROM</p> 	<p>The following accessories are attached to the unit.</p> <table border="1" data-bbox="594 911 1022 1107"> <tr> <td data-bbox="594 911 807 1107"> <p>Lens hood cap</p>  </td> <td data-bbox="807 911 1022 1107"> <p>XLR connector cap</p>  </td> </tr> </table>		<p>Lens hood cap</p> 	<p>XLR connector cap</p> 
<p>Lens hood cap</p> 	<p>XLR connector cap</p> 				

*1 For part numbers for the battery, see "Optional accessories". (Page 16)

*2 When using a USB connection cable (optional) or HDMI cable (optional), make sure to attach ferrite cores to the ends of the cable. Failure to attach ferrite cores could cause interference with nearby equipment. (Pages 83, 84)

- Please consult a retailer when purchasing additional accessories.

Optional accessories

- **Super-directional Electret Microphone**

AG-MC200G

- **XLR Microphone Adapter**

AG-MYA30G

- **Battery**

VW-VBG130 (7.2 V, 1320/1250 (typ./min.) mAh: compatible with supplied battery charger)

VW-VBG260 (7.2 V, 2640/2500 (typ./min.) mAh: equivalent to accessory battery)

VW-VBG6 (7.2 V, 5800/5400 (typ./min.) mAh: compatible with supplied battery charger)

- **Tele conversion lens**

VW-T4314H (See below for attachment instructions.)

- **Wide conversion lens**

VW-W4307H (See below for attachment instructions.)

Using tele conversion lenses, wide conversion lenses

Remove both the inner lens hood and outer lens hood before attaching an optional VW-T4314H tele conversion lens or VW-W4307H wide conversion lens.

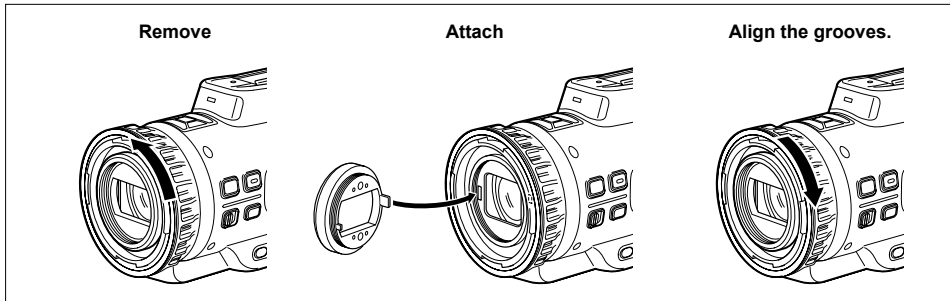

- Attach the ND filter and MC protector to the front of the lens hood (inner).

- Although you can attach both a filter and a conversion lens at the same time (such as attaching both an ND filter and a tele conversion lens), we do not recommend it, as the corners of images may appear darker (vignetting) during wide-angle zoom. (If you do attach both at the same time, remove the lens hood (inner) first.)

Description of parts

Right side and rear side

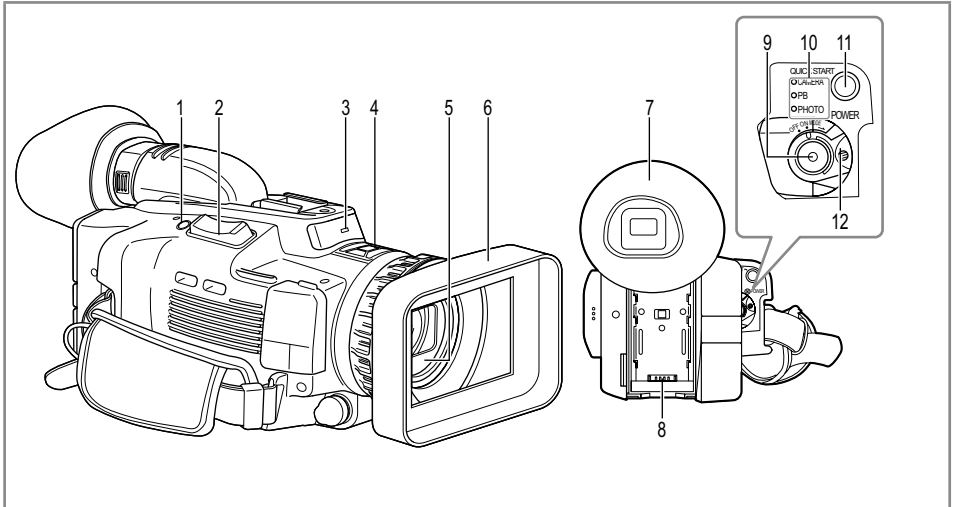

- 1 REC CHECK/PHOTO button (Page 61)
- 2 Zoom lever (Page 38)
- 3 Tally lamp (Page 27)
Remote control sensor (Page 26)
- 4 Built-in mic (Page 53)
- 5 Lens hood (inner) (Page 16)
- 6 Lens hood (outer) (Page 16)
- 7 Viewfinder (Page 29)
- 8 Battery compartment (Page 23)
- 9 START/STOP button (Page 34)
- 10 Mode lamp (CAMERA, PB, PHOTO)
(Pages 34, 61, 70)
- 11 QUICK START button (Page 27)
- 12 POWER switch (Page 26)

Before use

Description
of parts

Left side

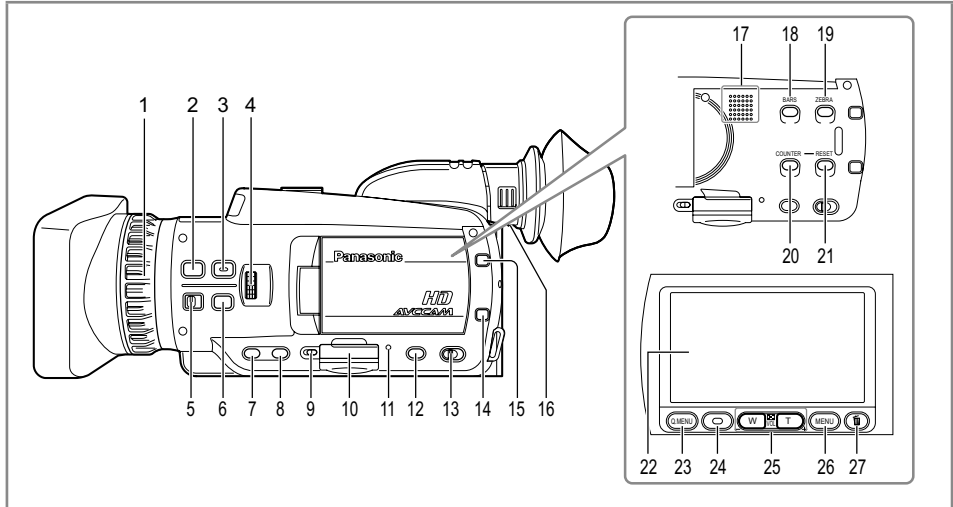

- 1 FOCUS ring (Page 40)
- 2 FOCUS ASSIST button (Page 41)
- 3 FOCUS button (Page 40)
- 4 IRIS dial (Page 41)
- 5 RING switch (Page 40)
- 6 WHITE BAL button (Page 42)
- 7 USER1 button (Pages 46, 106)
- 8 USER2 button (Pages 46, 106)
- 9 Card cover release lever (Page 33)
- 10 SD Memory Card cover (Page 33)
- 11 ACCESS lamp (Page 33)
- 12 USER3 button (Pages 46, 106)
- 13 AUTO/MANUAL switch (Pages 34, 40)
- 14 DISP/MODE CHK button (Page 45)
- 15 OIS button (Page 46)
- 16 Diopter adjustment lever (Page 29)
- 17 Speaker (Page 76)
- 18 BARS button (Page 47)
- 19 ZEBRA button (Page 45)
- 20 COUNTER button (Page 58)

- 21 RESET button (Page 58)
- 22 LCD monitor (Page 30)
- 23 Q.MENU button (Page 96)
- 24 START/STOP button (Page 34)
- 25 Zoom buttons (Page 38)
- 26 MENU button (Page 95)
- 27 Trash can button (Page 77)

Terminals and mounting parts

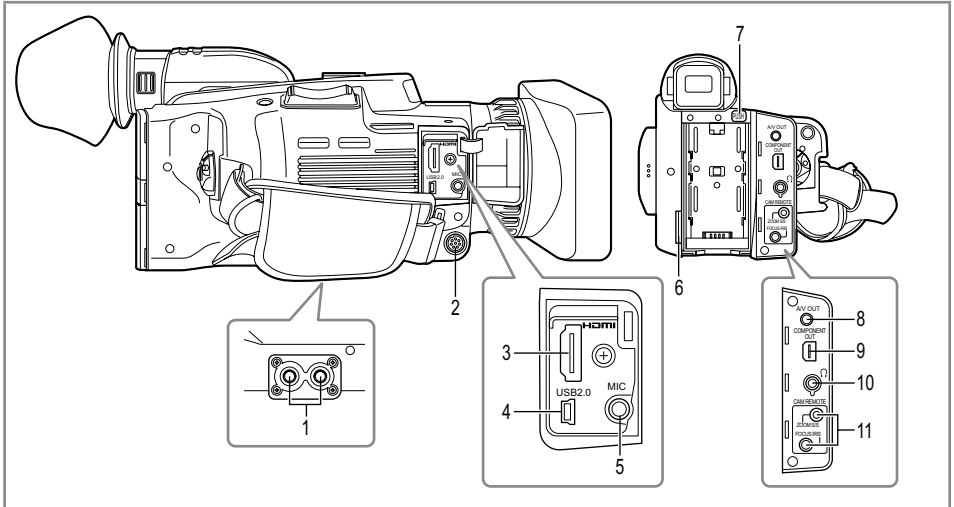

Description
of parts

- 1 Tripod hole (Page 11)
- 2 XLR adapter terminal (Page 82)
- 3 HDMI terminal (Page 84)
- 4 USB2.0 terminal (Pages 83, 85)
- 5 MIC terminal (Page 82)
- 6 Shoulder strap attachment point (Page 24)
- 7 Battery release button (Page 23)
- 8 A/V OUT terminal (Pages 83, 84)
- 9 COMPONENT OUT terminal (Page 84)
- 10 Headphone jack (Page 82)
- 11 CAM REMOTE jacks*

FOCUS/IRIS (3.5 mini jack)

You can connect a remote control unit to control the FOCUS and IRIS (aperture).
IRIS (aperture) control beyond OPEN is performed via gain adjustment, and can be set up to the standard gain setting.

ZOOM S/S (2.5 mm super mini jack)

You can connect a remote control unit to control zoom and start/stop of recording.



* Do not connect any equipment except the remote controller to the remote control jack. Connecting any equipment other than the remote control may cause the image brightness to change and/or the images to appear out of focus.

Remote control

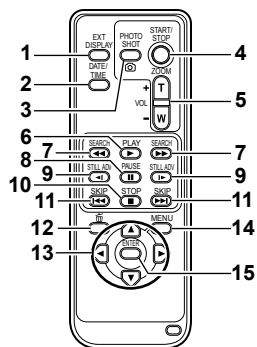
To use the remote control, set the IR REMOTE item on the OTHER FUNCTIONS menu to ON. The default setting for this item is OFF. (Page 109)



Remote control usable range (Page 26)

- 1 **EXT. DISPLAY button (Page 76)**
- 2 **DATE/TIME button (Page 76)**
- 3 **PHOTO SHOOT button (Page 61)**
Performs only the PHOTO function of the REC CHECK/PHOTO button on the camera.
- 4 **START/STOP button (Page 34)**
Used to select items and change setting values.
- 5 **ZOOM/VOL buttons (Pages 38, 76)**
- 6 **PLAY button (Pages 70, 71, 74)**
- 7 **SEARCH buttons (Pages 70)**
- 8 **PAUSE button (Page 71)**
- 9 **STILL ADV buttons (Page 71)**
- 10 **STOP button (Pages 70, 74)**
- 11 **SKIP buttons (Pages 71)**
- 12 **ENTER button (Page 77)**
Same function as the  button on the LCD monitor.
- 13 **OPERATION buttons**
Same function as  on the LCD monitor.
- 14 **MENU button**
Same function as the MENU button on the camera.
- 15 **ENTER button**
Used to confirm menus and items.

Recharging the battery

Recharging

The battery does not come ready charged when the camera is purchased. Charge the battery before use. It is recommended that you keep one extra battery as a spare.

1 Connect the power cable to the AC adapter.

Disconnect the DC cable.
(Battery cannot be charged if DC cable is connected.)

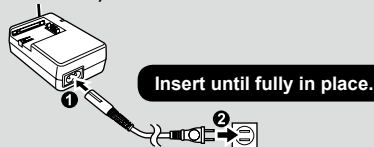

2 Insert the battery.

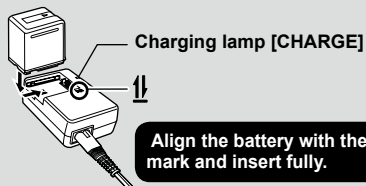

■ Charging lamp

On: Charging in progress
Off: Charging complete
Flashing: See below

■ If charging lamp is flashing

Check that there is no dirt, dust, or other substances attached to the connectors on the battery or AC adapter, and ensure that the adapter has been connected correctly.

- If there is dirt or dust on the connectors, disconnect the power plug from the socket before cleaning.
- If the charging lamp continues to flash, there may be a fault with the battery or the AC adapter. Please consult with the place of purchase.

■ Charging time and available recording time (Approx.)

Battery model	Voltage/capacity	Charging time	Maximum continuous recording time
VW-VBG130 (optional)	7.2 V/ 1320/1250 (typ./min.) mAh	Approx. 1 hr. 25 min.	Approx. 1 hr. 30 min.
VW-VBG260 (included)	7.2 V/ 2640/2500 (typ./min.) mAh	Approx. 2 hr. 50 min.	Approx. 3 hr. 15 min.
VW-VBG6 (optional)	7.2 V/ 5800/5400 (typ./min.) mAh	Approx. 5 hr. 50 min.	Approx. 7 hr.

- The figures in the table above are guidelines for use in normal temperature conditions (temperature 25 °C (77 °F), humidity 60%). Charging may take longer in higher or lower temperatures.
- Charging may take longer if the battery has not been in use for a long period of time.
- Given here are the approximate continuous recording times when recording using the viewfinder with no connections to any external devices and with the LCD monitor closed.
- Available recording time may vary according to usage conditions.
- Charging times are based on charging batteries from an empty state.

Description of parts

Preparation

(Continued on the next page)

Recharging the battery (continued)

■ Remaining battery capacity displays



When using Panasonic-manufactured batteries compatible with this product, the remaining battery capacity is displayed in hours and minutes.

 1h30m

Time remaining will be displayed after a brief pause.

- The battery display will change



as battery capacity decreases.  will be displayed in red when less than 3 minutes are remaining, and  will flash when the battery is empty.

- Remaining battery capacity may not be displayed correctly when using in high or low temperatures, or when the battery has not been used for a long period of time. To ensure that remaining battery capacity is displayed correctly, use the battery completely from a fully-charged state, and charge the battery again. (Remaining battery capacity may still not be displayed correctly if the battery has been used for long periods in high or low temperatures, or if the battery has been recharged a large number of times.)
- The remaining battery capacity display is a guideline and may change according to usage conditions.
- The remaining battery capacity display will momentarily disappear when switching between modes, when conducting REC CHECK operations or when changing the LCD brightness since the capacity is recalculated at these times.
- Not displayed when using AC adapter.
- The maximum time display for the remaining battery capacity is 9 hours 59 minutes.
- If the remaining battery capacity exceeds 9 hours and 59 minutes, the remaining time is displayed in green. This display does not change until the remaining time reaches 9 hours and 59 minutes and below.

-
- **Keep metal objects (such as necklaces and hairpins) away from the battery. Short-circuiting may occur across the terminals, causing the battery to heat up, and you may seriously burn yourself if you touch the battery in this state.**
 - The battery becomes hot while it is being used or charged. The camera-recorder itself also becomes hot during use.
 - The recordable time reduces if you repeatedly start and stop recording.
 - The battery takes longer to charge when it is warm.
 - The AC adapter can interfere with radio reception so keep radios at least 1 meter away from it.
 - The AC adapter may make some noise when you are using it, but this is normal.
 - Battery cannot be recharged when the DC cable is connected to the AC adapter.
-

Power sources

Using the battery

Installation

Insert the battery until it clicks into place.

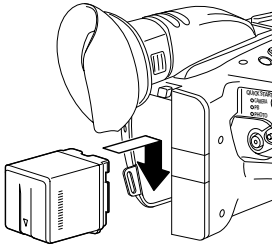

Removal

- 1 Set the POWER switch to OFF, and check that the mode lamp is off.
- 2 Remove the battery while pressing the battery release button.
 - Support the battery with your hand to ensure that it will not fall.

Battery release button Mode lamp

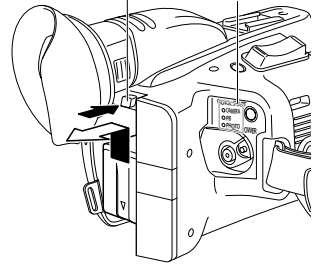

Preparation

Using the AC adapter

Installation

- 1 Connect the DC cable to the AC adapter.
- 2 Plug the AC power supply cable into the power outlet.
- 3 Insert the DC cable's battery connector until it clicks into place.

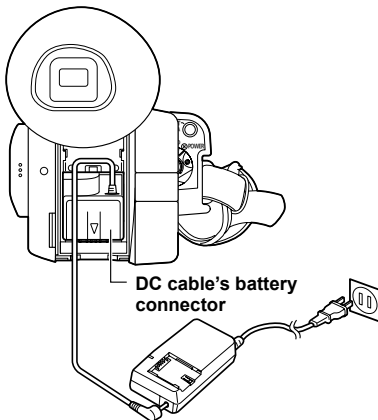

Removal

- 1 Set the POWER switch to OFF, and check that the mode lamp is off.
- 2 Remove the DC cable's battery connector while pressing the battery release button.
- 3 Disconnect the AC power supply cable from the power outlet.

- Battery cannot be recharged when the DC cable is connected to the AC adapter.
- Disconnect the AC power supply cable from the power outlet when the unit is not going to be used.

CAUTION:

- This apparatus can be operated at a voltage in the range of 110 – 240 V AC. Voltages other than 120 V are not intended for U.S.A. and Canada. Operation at a voltage other than 120 V AC may require the use of a different AC plug. Please contact either a local or foreign Panasonic authorized service center for assistance in selecting an alternate AC plug.

Adjusting the hand strap

Adjust the hand strap to suit your hand.

- 1 Open the cover and adjust the length.
- 2 Close the cover.
 - Make sure the cover is fully closed.

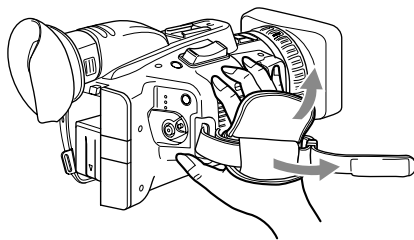

Attaching the shoulder strap

Attach the shoulder strap and use it as a precaution against dropping the camera.

When the handle is not attached

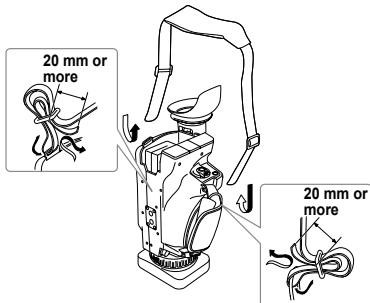

When the handle is attached

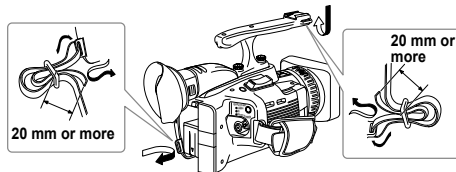

Detaching and attaching the lens hood

Detaching the lens hood

- Turn the lens hood counterclockwise to detach it.

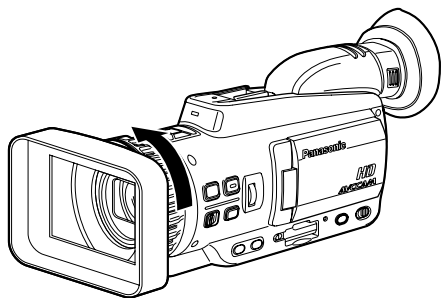

Attaching the lens hood

- Orient the lens hood with the arrow mark on top, rotate the hood counterclockwise (approx. 14°) to align the arrow with the one on the camera, and then slide the hood onto the camera.
- Rotate the lens hood clockwise to attach it.
- Be sure to attach the lens hood cap to protect the lens when not in use.

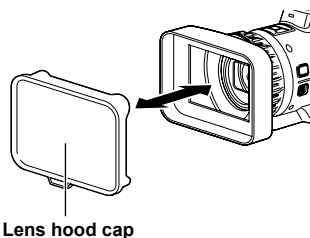
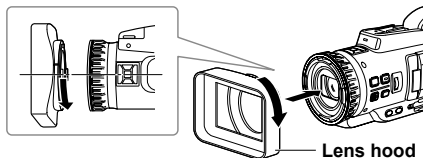

Attaching the handle

The handle comes in handy for taking low-angle shots or carrying the camera-recorder around.

- 1 Pull the viewfinder towards you.**
- 2 Slide the handle into place.**
- 3 Tighten the coin screw to secure the handle firmly.**
 - If the coin screw is loose, the camera-recorder may drop off.

-
- To remove the handle, first pull the viewfinder towards you, and then loosen the coin screw.
-

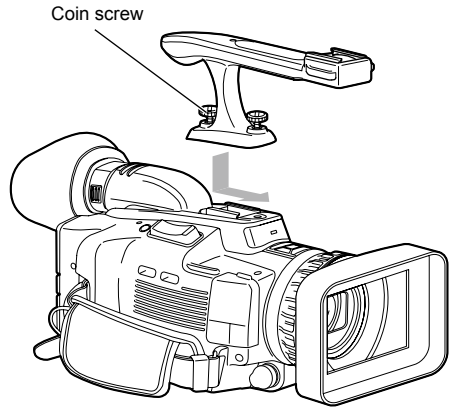

Preparation

Fitting the eye cup

Attach the eye cup by aligning the projections on the eye cup holder and eye cup and fitting them together.

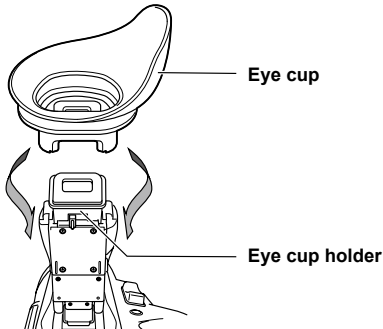

Fit the eye cup onto the viewfinder, and secure it in the direction of the arrow.

The remote control

Insert the battery

- 1 Push the catch in the direction shown by arrow ① to remove the holder.

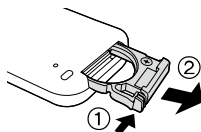

- 2 Insert the battery with the “+” marked side facing up.

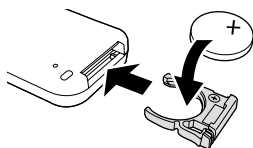

- 3 Return the holder to its original position.

- When the battery (CR2025) has run out, replace it with a new one. (The battery lasts about one year, depending on the frequency of use.)
If the remote control unit fails to work even when it is operated near the camera-recorder's remote control sensor, the battery has run out.
- **Keep the battery out of the reach of children.**

Remote control usable range

The distance between the remote control and the unit's remote control sensor: Within approx. 5 m
Angle: Approximately 15° upward, approximately 10° downward, approximately 15° leftward, or approximately 15° rightward
(Except when optional accessories are attached)

Remote control sensor

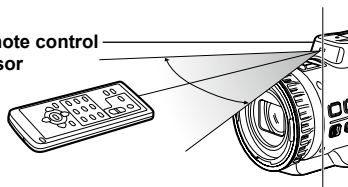

- The remote control is intended for indoor operation. Outdoors or under strong light, the unit may not operate properly even within the usable ranges.

Turn on/off the camera

While pressing the lock release button, move the POWER switch to ON or OFF.

Turn on the camera:

The mode lamp (CAMERA) lights red (camera mode), and the camera enters recording standby mode.

Turn off the camera:

The mode lamp (CAMERA) goes out.

• Energy-saving mode

According to the settings made in the POWER SAVE item of the OTHER FUNCTIONS screen in the settings menu, the following will apply if no designated operations* are performed for approximately five minutes in recording standby mode (when an SD Memory Card has been inserted while using the battery).

ON: The camera recorder turns off automatically.

OFF: Does not switch OFF the camera.

* See the setup menus, POWER SAVE (Page 110) for details.

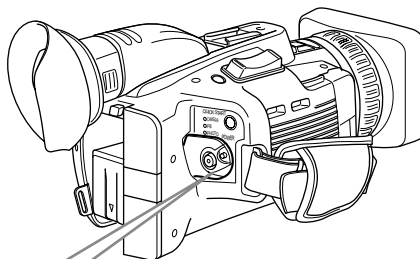

Mode lamp

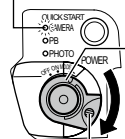

POWER switch

Set the POWER switch to the ON position while pressing the lock release button. The CAMERA lamp lights (red), and the camera enters recording standby mode.

Lock release button

Quick Start mode

This mode allows you to begin recording more quickly. When using Quick Start mode, you can begin recording approximately 1.5 seconds after Quick Start standby mode.

■ Setting

Hold down the QUICK START button for at least two seconds while the power is on. The camera will enter Quick Start standby mode and the CAMERA and PHOTO lamps will flash.

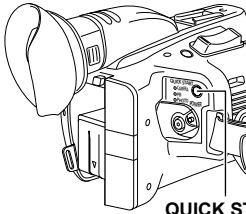

QUICK START button

■ To start recording

When the QUICK START button is pressed in the Quick Start standby mode (lamps flashing), the lamps light and the camera enters recording standby mode.

Tally lamp

You can set the tally lamp to light in the following situations by setting the REC LAMP item (Page 109) in the OTHER FUNCTIONS screen to ON.

- Battery is low (flashes 4 times per second)
- Available SD Memory Card capacity is low (flashes 4 times per second)
- Remaining battery capacity is low (flashes once per second)
- Remaining memory of the SD Memory Card is low (flashes once per second)

In addition, the tally lamp will flash regardless of the REC LAMP setting when receiving commands from the remote control.

- Quick Start mode will be canceled in the following cases.
 - The camera remains in Quick Start standby mode for more than 30 minutes
 - Battery is low
 - Battery has been removed
 - POWER switch is set to OFF

- **Quick Start standby mode consumes power, resulting in reduced total recording time.**
- Depending on recording settings, Quick Start may take longer than 1.5 seconds.
- Automatic white balance adjustment may take longer in Quick Start mode.
- The zoom ratio will be set to approximately x 1 wide end (Z00) with Quick Start.

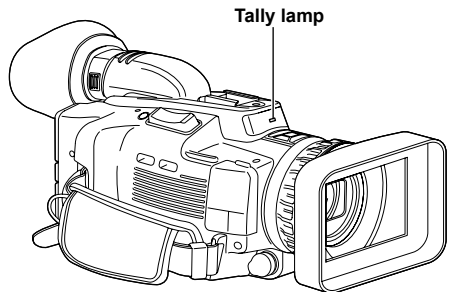

Touch panel

This camera utilizes a touch panel LCD monitor. You can navigate setting menus and other displays by touching items in the LCD monitor directly.

Using the touch panel

Icons are selected when you release your finger from the touch panel after pressing them.

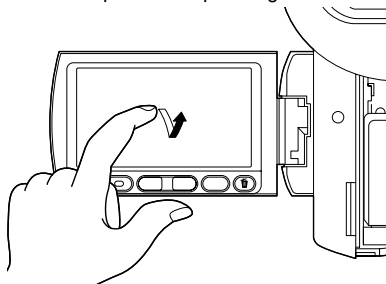

- If you touch another part of the screen without removing your finger from the touch panel, the selection will not be made.
- Use the touch pen (supplied) if you have difficulty making precise selections with your fingers. Do not use touch pens other than the one supplied.

Frequently used icons

▲▼◀▶:

Touch these to scroll through the pages of menu and thumbnail screens or to adjust setting values.

Example:

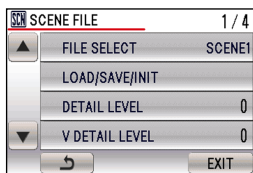

Example:

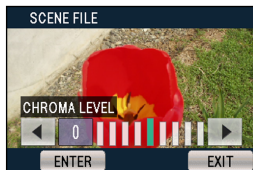

Touch this to return from a function or setting screen to a previous screen.

Example:

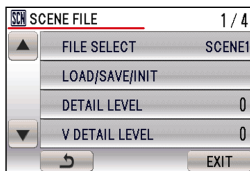

- Use soft cloth, such as glasses cleaning cloth, to clean or wipe fingerprints off of the LCD monitor.
- Do not use ballpoint pens or other pointed objects to touch the LCD monitor.
- Do not touch the LCD monitor with your nails or scratch and press the monitor with excessive force.
- Applying a protective sheet to the LCD monitor may reduce visibility and touch recognition.
- If your touch is not recognized or other parts of the screen are recognized, adjust the CALIBRATION item in the OTHER FUNCTIONS screen. (Page 31)

Viewfinder

This camera has two viewfinders; one is a miniature LCD in the viewfinder and the other is a retractable 2.7-inch LCD.

Use the viewfinder that best suits the application and shooting conditions.

- The brightness and hue may differ between the images appearing on the viewfinder and LCD monitor and those displayed on a TV monitor. To see how the final images will appear, check them on a TV monitor.

Using the viewfinder

1 Set the POWER switch to ON, and check that images appear in the viewfinder.

- Leave the LCD monitor closed.
- You can display images in both the LCD monitor and viewfinder at the same time by setting the EVF MODE item in the setting menu SW&DISP SETUP screen to ON.

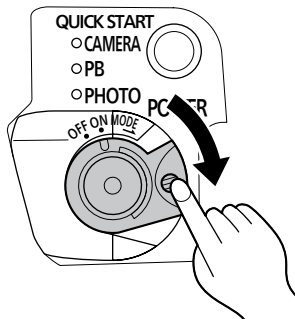

2 Adjust the angle of the viewfinder to a convenient viewing position.

- The viewfinder can be raised to about 70° from the camera.

3 Adjust the diopter adjustment lever until text display in the viewfinder is clear.

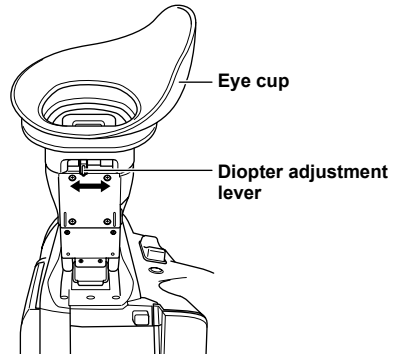

- Do not point the viewfinder directly at the sun. Doing so may damage internal components.

Using the LCD

1 Set the **POWER** switch to **ON**. (Page 26)

2 Open the **LCD** monitor.

The monitor opens up to 90°. Attempting to open it further with force may damage the camera.

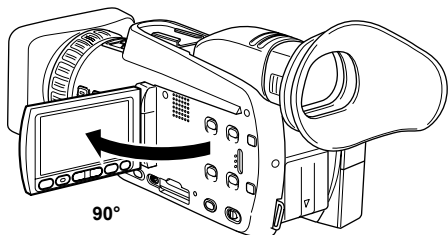

3 Adjust the angle of the LCD monitor to a convenient viewing position.

- The monitor can be rotated 180° toward the lens and 90° toward the eye piece.
- **Attempting to rotate it further with force or closing it in a 90° position may damage the camera.**

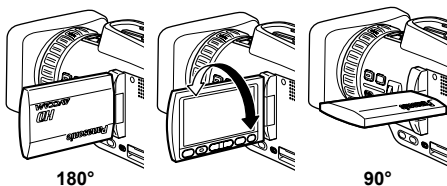

- When closing the LCD monitor, be sure to close it fully.
- When the LCD monitor is facing the lens (during self-portrait recording), both the viewfinder and the LCD monitor will be lit.

Emphasizing outlines

When EVF DTL is assigned to one of the USER buttons 1 to 3, you can press that button to emphasize the outlines of images in the viewfinder or LCD monitor, and make focus alignment easier. Emphasizing the outlines does not effect the images you shoot.

1 Touch **USER1 SW**, **USER2 SW**, or **USER3 SW** in the setting menu **SW&DISP SETUP** screen.

2 Touch **EVF DTL**.

EVF DTL is assigned to the selected USER button.

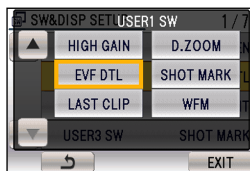

3 In **CAMERA** mode or **PHOTO** mode, press the **USER** button assigned to **EVF DTL**.

“EVF DTL ON” appears in the center of the screen for about 2 seconds.

To release the setting, press the USER button assigned to EVF DTL again, and “EVF DTL OFF” appears in the center of the screen for approximately 2 seconds.

Adjusting the screen display

1 Set the **POWER** switch to **ON**. (Page 26)

2 Press the **MENU** button.

- Menu operation (Page 95)
- Operations may also be performed using buttons on the remote control that correspond to those on the camera. For details, see “Description of parts (Remote control)”. (Page 20)

3 **Viewfinder adjustments**

Set **YES** under **EVF SET** on the setting menu **SW&DISP SETUP** screen.

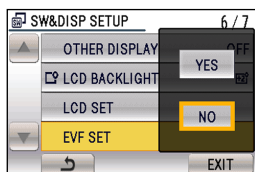

LCD monitor adjustments

Set **YES** under **LCD SET** on the setting menu **SW&DISP SETUP** screen.

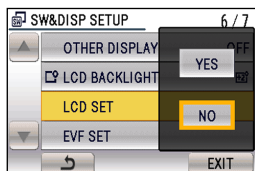

4 Touch the item you want set.

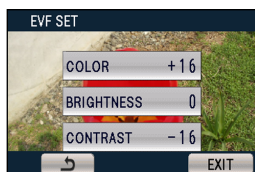

5 Touch **◀** or **▶** to adjust the selected item.

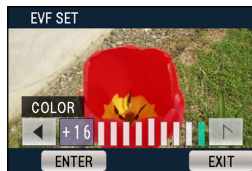

6 Touch **ENTER**.

- Touch **EXIT** or press the **MENU** button to finish configurations.

- The viewfinder display can be in color or black and white. (See the setup menus, **SW&DISP SETUP** screen, **EVF COLOR**.) The resolution is the same for both of them.

Adjusting the touch panel

Adjust touch panel calibration if items that you do not intend to select are selected when you touch the panel.

1 Touch **YES** for **CALIBRATION** in the setting menu **OTHER FUNCTIONS** screen.

- Touch **ENTER** when the confirmation message appears.

2 Touch **[+]** using the supplied touch pen.



- Touch **[+]** as they appear (5 total).

3 Touch **ENTER**.

- You cannot perform adjustment when the LCD monitor is rotated 180°.

Setting the calendar

The CLOCK SET value is recorded in the contents (clip), and affects the sequence of playback of the thumbnails. Before carrying out recording, be sure to check and set CLOCK SET and TIME ZONE. This shows you how to adjust the calendar to 17:20 on December 25, 2009.

Setting the time zone

1 Set the POWER switch to ON. (Page 26)

2 Press the MENU button.

- Menu operation (Page 95)
- Operations may also be performed using buttons on the remote control that correspond to those on the camera. For details, see “Description of parts (Remote control)”. (Page 20)

3 Touch YES for TIME ZONE in the setting menu OTHER FUNCTIONS screen.

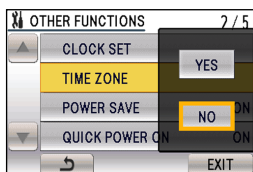

4 Touch the time zone display, and touch ▲ or ▼ to select the difference from Greenwich Mean Time.

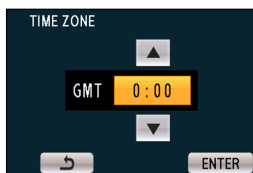

- The factory default setting is +0:00.

5 Touch ENTER.

- The clock can vary in accuracy, so check that the time is correct before shooting.
- When using the camera overseas, do not set the CLOCK SET option to the local time, but enter the time difference from Greenwich Mean Time using the TIME ZONE option instead. (Page 109)

Setting the clock

1 Set the POWER switch to ON. (Page 26)

2 Press the MENU button.

- Menu operation (Page 95)
- Operations may also be performed using buttons on the remote control that correspond to those on the camera. For details, see “Description of parts (Remote control)”. (Page 20)

3 Touch YES for CLOCK SET in the setting menu OTHER FUNCTIONS screen.

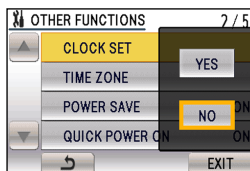

4 Touch the item you want to set, and touch ▲ or ▼ to set the value.



5 Repeat the procedure from step 4 to set the remaining items.

- The date can be set to any date between January 1, 2001 and December 31, 2039.
- “--.--” is displayed for any date beyond December 31, 2039.
- The time is displayed in 24-hour format.

6 Touch ENTER.

7 Touch EXIT or press the MENU button when you are finished configuring items.

Basic shooting operations

Preparing for recording

1 Set the camera's power switch to OFF. (Page 26)

- Check that the mode lamp is off.

2 Slide the card cover release lever, and open the SD Memory Card cover.

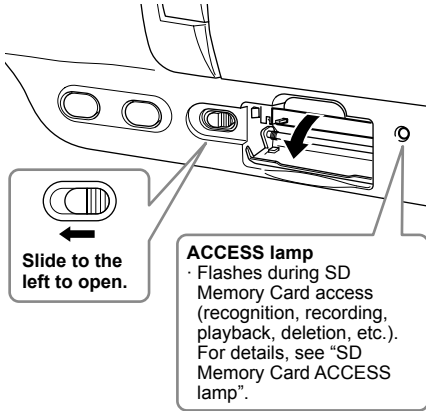

3 Fully insert an SD Memory Card into the card slot.

- Insert the card in the direction shown until it clicks into place.

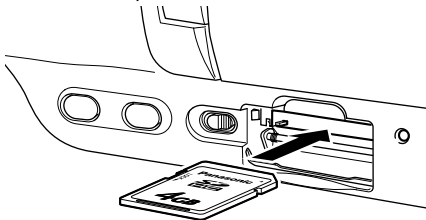

4 Close the SD Memory Card cover.

- Ensure that the cover firmly clicks into place.

- Do not perform any of the following operations while the SD Memory Card ACCESS lamp is flashing.

Performing these operations may damage the SD Memory Card or its contents, or cause the camera to fail to operate correctly.

- Opening the card door and removing the SD Memory Card
- Switching off the power
- Removing the battery
- Connecting or disconnecting the USB connection cable
- Shaking or striking the camera
- Always format SD Memory Cards that have been used in other devices when first using them with this camera. (Page 35)
- If "CHECK CARD" is displayed on the viewfinder or the LCD monitor, please remove the SD Memory Card and insert it again.

SD Memory Card ACCESS lamp

This lamp lights or flashes during memory card access.

Lit: Card inserted, read/write possible

Flashing (fast): Recognizing

Flashing (slow): Accessing (during recording/
playback/reading)

Off: Card not inserted, unformatted card inserted

SD Memory Card access lamp

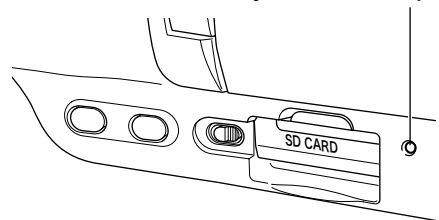

Shooting in auto mode

1 Turn the POWER switch to ON. (Page 26)

- Check that the mode lamp (CAMERA) is lighted red.

2 Switch the AUTO/MANUAL switch to AUTO to select auto mode.

- **A** appears on the viewfinder and LCD monitor.
- The focus, shutter speed, gain, iris, and white balance are adjusted automatically. In addition, if the AUTO SW item in the setting menu SW&DISP SETUP screen is set to FACE DETECT ON, focus is automatically aligned on faces detected in the image and brightness is adjusted for optimal results. **A** appears when FACE DETECT ON is set.
- Up to 15 face detection frames can be displayed on the screen at one time. Larger frames and frames closer to the center have priority.
- When FACE FRAMING is set to ALL and multiple subjects are detected, only the frame on which focus is aligned is displayed in orange. All other frames are displayed in gray.
- Primary (priority) frames
The primary frame is displayed in orange. Focus is automatically aligned to the primary frame, and the brightness is adjusted. When you press the REC CHECK/PHOTO button halfway in PHOTO mode, focus is aligned to the primary frame. When focus is aligned, the primary frame turns green.

3 Press the START/STOP button (Red) to start shooting.

- Press again to enter recording standby mode.
- Shooting is not possible when a menu screen is displayed. First, close the menu screen, and then press the START/STOP button.
- Shooting stops when the SD Memory Card cover is opened during shooting.

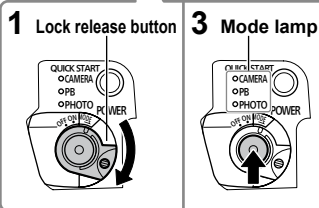
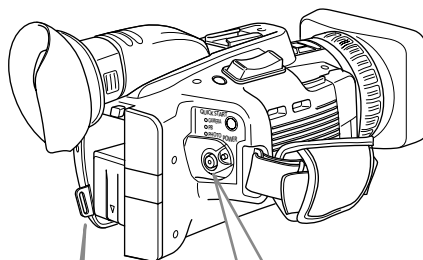

3 Mode lamp

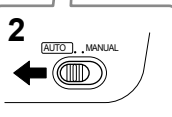
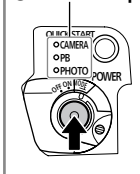

- The images shot from when shooting starts until it is stopped are recorded as one clip.
- When recording is paused after a short period, a small amount of time may be required after pressing the START/STOP button to stop recording before writing to the SD Memory Card is terminated. This means that operations cannot be accepted if the START/STOP button is pressed immediately.
- The camera will read information from the SD Memory Card immediately after the card is inserted. Press the START/STOP button to begin recording after **PA** (pause) is displayed in the operation status display. (Page 87)
- The camera's factory default setting is PH mode 1080/60i recording. (To view current setting status: Page 45)
- The upper limit for the number of clips which can be recorded on a single SD Memory Card is 900. (However, this number may exceed 900 clips at times such as when shooting immediately after the POWER switch has been set to ON.)

Checking photos taken (REC CHECK)

Press the REC CHECK/PHOTO button while in recording standby mode. The last two seconds of video and audio will be played, and the camera returns to recording standby mode.

- Only the POWER and START/STOP buttons are operable during REC CHECK.
- The REC CHECK images are also recorded when a device is connected to the camera and backup images have been recorded.
- The REC CHECK function does not work when PB has been selected as the operation mode or when connected to a computer.
- This function also does not work if the REC FORMAT has been changed or if the camera has been set to CAMERA mode after having switched to PB mode after recording.
- The REC CHECK function does not work after interval recording.
- This function does not work if the SD Memory Card is removed and reinserted.

Formatting SD Memory Cards

- 1 Set the camera's power switch to ON.**
(Page 26)
- 2 Press the MENU button.**
- 3 Touch YES for CARD FORMAT in the setting menu OTHER FUNCTIONS screen.**
 - Press the MENU button or touch EXIT to close the menu display.

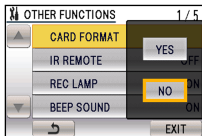

- 4 Touch YES on the confirmation screen.**
 - The SD Memory Card will be formatted.
- 5 Touch EXIT.**
 - When an SD Memory Card is formatted, all data recorded on the card will be erased and will not be restorable.
Save all important data to your computer.

Basic shooting operations (continued)

SD Memory Card recording times

Total available recording times (approx.) when using SD/SDHC Memory Cards manufactured by Panasonic

SD Memory Card capacity	Recording mode			
	PH*1 (Highest quality mode*3/ 1920 × 1080 pixels or 1280 × 720 pixels)	HA*1 (High quality mode/ 1920 × 1080 pixels)	HG*2 (Standard quality mode/ 1920 × 1080 pixels)	HE*2 (Long duration mode/ 1440 × 1080 pixels)
512 MB	Approx. 2 min	Approx. 3 min	Approx. 4 min	Approx. 10 min
1 GB	Approx. 5 min	Approx. 7 min	Approx. 9 min	Approx. 21 min
2 GB	Approx. 10 min	Approx. 15 min	Approx. 20 min	Approx. 45 min
4 GB	Approx. 21 min	Approx. 30 min	Approx. 40 min	Approx. 90 min
6 GB	Approx. 33 min	Approx. 45 min	Approx. 60 min	Approx. 135 min
8 GB	Approx. 45 min	Approx. 60 min	Approx. 80 min	Approx. 180 min
12 GB	Approx. 65 min	Approx. 90 min	Approx. 120 min	Approx. 270 min
16 GB	Approx. 90 min	Approx. 120 min	Approx. 160 min	Approx. 360 min
32 GB	Approx. 180 min	Approx. 240 min	Approx. 320 min	Approx. 720 min

*1 Use an SD memory class of SD speed class 4 or above when recording on PH mode or HA mode. Recording cannot be completed on SD Memory Cards of lower speed classes.

*2 We recommend using an SD memory card of SD speed class 2 or above when recording in HG mode or HE mode.

*3 This is the highest quality mode of this camera.

- This camera uses the VBR recording system. “VBR” stands for Variable Bit Rate, and it refers to a system in which the bit rate (volume of data per given time period) varies automatically depending on the subject which is being shot. This means that the recording times will be shorter when fast-moving subjects have been recorded.
- Times displayed include time needed for processing, etc. – actual available recording times will be slightly shorter.
- The camera is capable of continuous recording for a maximum of 12 hours.
- Mosaic-like noise may appear on the playback screen under the following shooting conditions:
 - When there are complex patterns in the background
 - When the camera is moved in large motions or when it is moved very quickly
 - When a fast-moving subject has been recorded (and especially when HE has been set as the recording mode)
- Repeatedly recording or deleting images over and over again may reduce the recording time on the SD Memory Card. In such cases, format the SD Memory Card using the camera. When a card is formatted, all of its recorded data will be erased, and it will not be subsequently possible to restore this data. Save any valuable data on your PC prior to formatting.

Removing SD Memory Card

1 Slide the card cover release lever, and open the SD Memory Card cover.

- Make sure that the SD Memory Card ACCESS lamp is not flashing orange before opening the cover.

2 Press the center of the SD Memory Card so that it pops out slightly, and pull the card straight outwards.

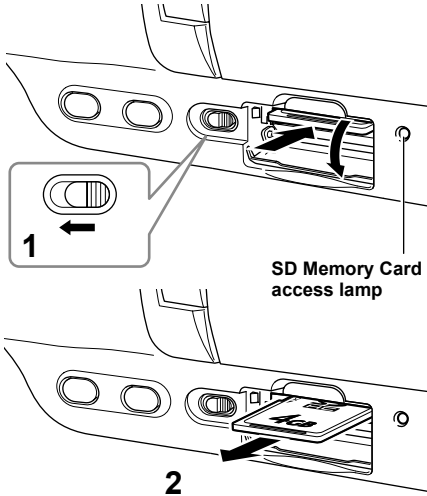

- Do not remove the SD Memory Card or switch off the power in the following circumstances. Doing so may damage your SD Memory Card.

- 1) While the SD Memory Card ACCESS lamp is flashing orange after inserting an SD Memory Card.
- 2) While the SD Memory Card ACCESS lamp is flashing during recording, recording finalization, and other operations.

Protecting SD Memory Cards

Move the write-protect switch on the SD Memory Card to the "LOCK" position to prevent recorded contents being accidentally erased from the card.

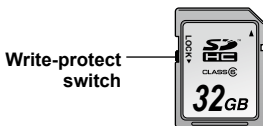

Repairing SD Memory Cards

Never remove the SD Memory Card or disconnect the battery or DC cable while the SD Memory Card ACCESS lamp is flashing, as doing so may damage the SD Memory Card. In the event the SD Memory Card is removed while the SD Memory Card access lamp is flashing, or the battery or DC cable is disconnected during a recording or recording finalization process, a repair verification screen will appear the next time the power is turned on to allow errors to be repaired.



Select YES to begin repairing. When repairing is complete, "REPAIR FINISHED" will be displayed, and the camera will switch to the recording paused screen. Select NO to switch directly to the recording paused screen without repairing.

- Memory cards cannot be repaired with the camera if NO is selected, but can still be repaired by using the AVCCAM Restorer* contents repair software.
- An SD Memory Card on which an error occurred can be repaired by using either the camera that was used for the shooting, or the AVCCAM Restorer contents repair software.
- A repair confirmation message may be displayed after inserting an SD Memory Card which has no error, but repair will not be performed even when YES or NO is selected.
- Repair may take up to 20 minutes or so depending on the places where the errors occurred on the card.
- Use a battery with an adequate charge or the AC adapter.
- If the repair operation has failed, "SYSTEM ERROR TURN POWER OFF" will be displayed. In this case, please use the AVCCAM Restorer contents repair software. Depending on the status of the data, it may not be possible to restore all data completely. In this case, it will no longer be possible to play back the clips that were recorded before the SD Memory Card was ejected or the power was turned off.
- Clips with a total recording time of less than 10 seconds may not be able to be repaired.
- Shot marks added during recording cannot be repaired.

* AVCCAM Restorer is included on the supplied CD-ROM. For details on how to install it, refer to install.txt.

For details on how to use it, read the operating instructions (PDF file).

The AVCCAM Viewer can also be downloaded from the following website.

<https://eww.pavc.panasonic.co.jp/pro-av/>

Using the zoom function

This camera has a 12 x optical zoom function. Use the zoom lever or assign zoom functions to the FOCUS ring to perform zoom operations.

Zoom lever

Gently press the zoom lever to zoom slowly, firmly press to zoom faster.

T: Zoom in

W: Zoom out

When using the zoom buttons on the LCD monitor, the zoom speed is constant.

- With the SMOOTH ZOOM STOP item in the setting menu SW&DISP SETUP screen, you can select a mode that smoothes the zoom stop operation.

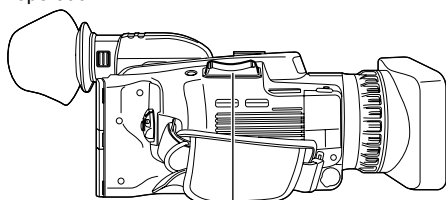

Zoom lever

On the remote control

Press the ZOOM/VOL buttons to zoom.

- Zoom speed is fixed at medium.

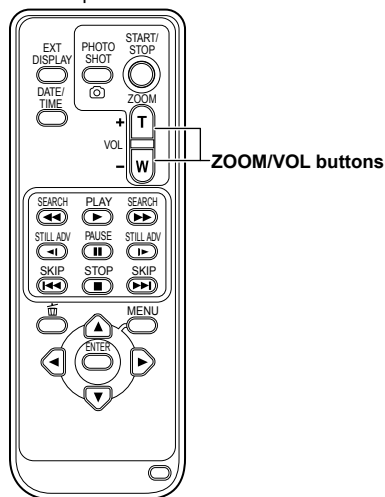

Digital zoom function

By setting D.ZOOM to any of the USER 1 - 3 buttons, you can use the camera's digital zoom function. (Page 106)

With each press of the USER button to which D.ZOOM has been allocated, the digital zoom ratio will be switched between OFF (x 1)→x 2→x 5→x 10→OFF.

- The higher the zoom ratio setting, the poorer the image quality.
- For all settings other than OFF (x 1), the current zoom ratio will be displayed in the viewfinder or the LCD monitor.
- The digital zoom function can only be used with the 1080/60i and 720/60P recording formats.
- The digital zoom function cannot be used while touch auto focus is enabled.
- The digital zoom function cannot be used in PHOTO mode.
- The digital zoom function cannot be used with interval recording.

- When using a macro range and AF or MF on the focus control information display appears in reverse black and white, zooming may cause the image to become unfocused.

Shooting in progressive mode

Selecting 1080/30P or 1080/24P for the REC FORMAT option in the setting menu RECORD SETUP screen (Page 102) enables shooting in progressive mode.

In 720 mode, the camera always shoots in progressive mode.

Note the following when shooting in progressive mode.

- There may be a slight delay to the start of recording when you use the 24P mode because 4 frames are recorded at a time.

30P mode (with 1080 mode):

Shoot 30 frames a second in the progressive mode.

For output and recording, the 30-frame-per-second signal is converted to 60-field-per-second interlace.

This mode gives you high quality images.



24P mode (with 1080 mode):

Shoot 24 frames a second in the progressive mode.

The video signal will be recorded natively. However, the external output signal is converted to a 2:3 format, 60 fps interlaced signal.

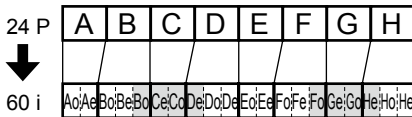

Shooting in manual mode

Set the unit to manual mode when manually adjusting the focus, shutter speed, iris, gain and white balance.

Switching to manual mode

Move the AUTO/MANUAL switch to the MANUAL position to select the manual mode. (**A** will disappear from the viewfinder or the LCD monitor.)

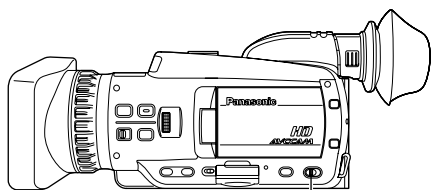

AUTO/MANUAL switch

Manual focusing

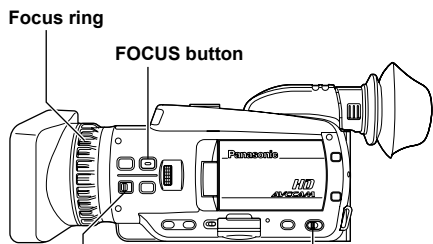

RING selector switch

AUTO/MANUAL switch

1 Use the AUTO/MANUAL switch to set to manual mode.

2 Use the FOCUS button to switch the focus mode.

Pressing the FOCUS button switches to manual focus mode where "MF" appears on the screen. Pressing the FOCUS button again switches to auto focus mode where "AF" appears on the screen.

- Holding down the FOCUS button sets the focal length to infinity and causes "MF95" to appear on the screen.

When switching from auto mode to manual mode:

- Iris and focus are set to AUTO.
You can switch them to manual mode by pressing the IRIS button and FOCUS button.
- Shutter speed
CAMERA mode preserves the AUTO mode shutter speed. PHOTO mode preserves the AUTO mode state. You can change the shutter speed by using the Function Navi.
- The shortest distance from a back-focusing lens differs depending on the zoom position.
- When using a macro range and AF or MF on the focus control information display appears in reverse black and white, zooming may cause the image to become unfocused.

3 The function allocated to the focus ring can be changed with the RING switch.

FOCUS:

Adjust the focus.

ZOOM/IRIS:

Adjust the zoom or iris (aperture) setting.

You can change which functions are assigned from the menus.

The factory default setting is ZOOM.

Temporarily switching to auto focus

You can also use auto focus mode while in manual mode by assigning the (PUSH)AF function to one of the USER buttons 1 to 3. Auto focus mode will be enabled for as long as the USER button is pressed, and the focal point will be automatically adjusted.

You can also align focus with touch auto focus. (Page 44)

- Auto focus may not work properly if there is flickering. Select a shutter speed suited to the ambient light. (Page 50)
- If the auto focus mode is set with any format except 60i and 60P, controlling the focus will take slightly longer than in the normal focus mode.
- During macro shooting "AF" or "MF" will be displayed in a frame on the screen.

Using focus assist

Pressing the FOCUS ASSIST button enlarges the center of the viewfinder and LCD monitor screens, or displays a bar at the bottom center of the screen. These displays make aligning the focus easier and are particularly useful in manual focus mode. The display that appears when the FOCUS ASSIST button is pressed can be configured with the FOCUS ASSIST SW item in the setting menu SW&DISP SETUP screen. (Page 106)

FOCUS ASSIST button

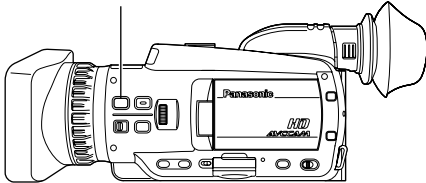

EXPANDED:

The central part of the screen will be enlarged by a factor of about 4 in the vertical direction and by a factor of about 6 in the horizontal direction. A blue box will appear in the viewfinder and LCD monitor screens during expanded display. Only the operation status display and counter will appear on the screen.

- The center of the angle of view is shifted slightly from the center of the LCD monitor.

BAR:

A bar will appear at the bottom center of the viewfinder and LCD monitor screens, indicating the level of focus alignment with its length. The peak hold mark (▼) appears over the bar, and the bar expands to the right as focus is aligned.

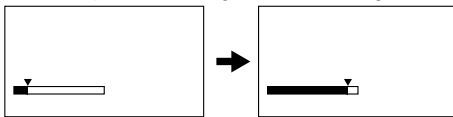

Focus not aligned

Bar expands to right as focus is aligned

BOTH:

Displays both the expanded display and focus bar.

- This function cannot be used while the digital zoom function is in use.
- Press the FOCUS ASSIST button again to return to the original screen.

Setting the aperture and gain

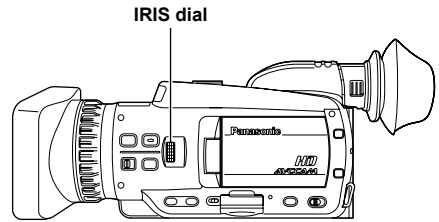

- 1 Use the AUTO/MANUAL switch to set to manual mode. (Page 40)**
- 2 Press the IRIS dial to switch the method of adjustment for the aperture of the lens.**
The method switches to AUTO IRIS or MANUAL IRIS with each press of the dial.
AUTO IRIS: Adjust the iris automatically.
MANUAL IRIS: Adjust the iris manually.
- 3 Turn the IRIS dial to adjust the aperture of lens when in the manual iris mode.**

- In the auto iris mode, the lens iris can be corrected using this dial.
- Increase in brightness beyond the maximum aperture (OPEN) is performed via gain adjustment (CAMERA mode: 0 to 24 dB; PHOTO mode: 0 to 18 dB).
- If further gain adjustment is necessary, assign HIGH GAIN to one of the USER buttons 1 to 3. The gain mode switches between normal and high with each press of the button.
Gain can be set to up to 34 dB in high gain mode.
In PHOTO mode, switching to high gain mode is disabled.
- Set the direction of the IRIS DIAL and aperture control in the setup menus, SW&DISP SETUP screen, IRIS DIAL.
- The lens aperture can be adjusted in the focus ring by setting the RING switch to IRIS. The relationship between the direction of rotation and aperture control is based on the IRIS DIAL setting in the SW&DISP SETUP screen. However, as this will make it impossible to adjust the focus in the focus ring, please set the focus control method to A (AUTO) with the FOCUS switch. Zoom control can also be assigned to the FOCUS ring. (Page 40)
- As you shrink the aperture to a near closed state, resolution will decrease due to light diffraction. You can prevent this by adjusting the shutter speed and increasing the aperture size.

Adjusting the white balance and black balance

When white balance adjustments are performed, black balance adjustments are performed at the same time.

White balance

In order to reproduce the white accurately, adjust the ratio between the three RGB primary colors. If the white balance is not adjusted properly, not only will the white be reproduced poorly but the color tones of the entire screen will also be downgraded. When you are shooting in manual mode, readjust the white balance whenever lighting conditions change.

You can store white balance adjustments to Ach and Bch of the Function Navi.

You can also use the preset values.

Use the settings to suit the shooting conditions.

Black balance

Adjust the ratio between the three RGB primary colors to reproduce black accurately. If the black balance is not adjusted properly, not only will black be reproduced poorly, but the color tones of the entire screen will also be downgraded.

Black balance adjustment is usually not necessary, but be sure to perform it in the following cases.

- When using the camera for the first time.
- When using the camera after extended periods of disuse.
- When using the camera after large changes in ambient temperature.
- After setting the shutter speed to standard or low speeds.
- After switching between progressive mode and standard (60i) mode.

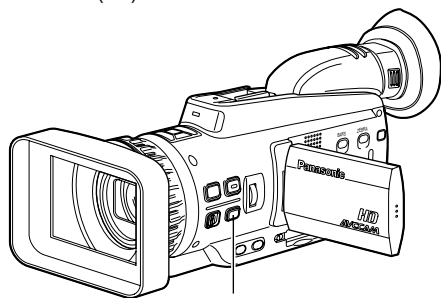

WHITE BAL switch

White balance and black balance adjustments

- 1 Use the AUTO/MANUAL switch to set to manual mode. (Page 40)**
- 2 Set the shutter speed. (Page 50)**
- 3 Place a white pattern in a location with the same lighting conditions and light source as the subject, then zoom in and fill the whole screen with white.**
Something white (a white cloth or wall) near the subject can be used instead.
 - Do not include bright spotlights in your shot.
- 4 Press the WHITE BAL button to display Ach or Bch.**
The mode changes in order from ATW→ATW LOCK→P3.2K→P5.6K→Ach or Bch→ATW with each press of the button.
- 5 Touch the LCD monitor and display the Function Navi.**
- 6 Touch  to display the operation menu.**
- 7 Touch Ach or Bch.**
- 8 Press and hold the WHITE BAL button.**
 - Adjustment takes a few seconds.
(The following messages appear on the screen.)

Message during adjustment

AWB ABB
ACTIVE

Message after adjustment

AWB ABB OK

- An error message appears on the screen when white balance adjustment is not possible.

Message when adjustment cannot be done

AWB NG

-
-
- White balance cannot be adjusted if the ATW (Auto Tracking White) function is working.
 - Black balance cannot be adjusted during recording.
 - White balance cannot be adjusted during auto mode. Only black balance can be adjusted.
 - White balance cannot be adjusted if the shutter speed is set to less than 1/24.
-
-

Using presets

Use this feature when you have no time to make white balance adjustments.

1 Use the AUTO/MANUAL switch to set to manual mode. (Page 40)

2 Press the WHITE BAL button.

The mode changes in order from ATW→ATW LOCK→P3.2K→P5.6K→Ach or Bch→ATW with each press of the button.

- Guide to the preset values
P3.2K (3200 K): halogen light
P5.6K (5600 K): outdoors

Auto Tracking White (ATW)

Using the ATW function enables the recording environment to be automatically analyzed and an optimum white balance to be constantly maintained during recording.

To use the ATW function, set the white balance to ATW mode by pressing the WHITE BAL button.

-
-
- Depending on the environment, there may be some error in the adjustment.
 - Use the procedure described on the previous page whenever you need more precise white balance.
-
-

Shooting techniques for different targets

Touch auto focus (CAMERA mode only)

You can align focus on a subject by touching the LCD monitor.

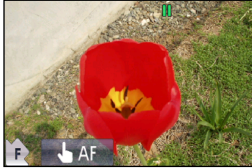

- 1 Set the **POWER** switch to **ON**. (Page 26)
- 2 Touch the **LCD monitor** and display the **Function Navi**.
- 3 Touch  to display the operation menu.



- 4 Touch  **AF**.

The active area frame (red) for touch auto focus appears for about 2 seconds after **AF** is touched.

The area inside this frame is active.

-  **AF** appears.
- You can make **CANCEL** disappear by touching . To make it reappear, touch .
- If the face detection function is enabled in **AUTO** mode, the face detection frames (orange) will disappear temporarily.

- 5 Touch the subject on which to align focus.

- In auto focus mode, the focus frame (green) appears on the touched position and focus is aligned.
- In manual focus mode, the focus frame will disappear after focus is aligned on the touched position.
- To change the position of the focus frame, touch a different area of the LCD monitor. If you touch outside the active focus area, the active area frame (red) appears for about 2 seconds.

■ Canceling touch auto focus

Touch **CANCEL** to cancel touch auto focus.

- Touch auto focus will not function in the following conditions.
 - Dark shooting conditions
 - Fast-moving subjects
 - Excessive camera shake
 - Zoom is in use
- Touch auto focus will be canceled in the following cases.
 - The camera is turned off or the mode is switched.
 - The focus mode is switched from auto to manual, or vice versa.
- The digital zoom and focus assist functions cannot be used while touch auto focus is enabled.
- If you enable touch auto focus while digital zoom is in use, digital zoom will be disabled. The screen display will return to standard display and switch to touch auto focus mode.

Self-portrait shooting

Images in the LCD monitor when it is turned 180° for self-portrait shooting may appear unusual. You can make them appear better by reversing left and right. Go to the setup menus, **SW&DISP SETUP** screen, **SELF SHOOT**, and select **MIRROR**. Shooting in mirror mode has no effect on what you actually shoot and record.

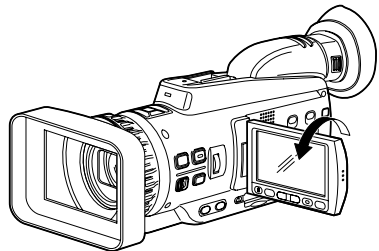

- If you press and hold the **DISP/MODE CHK** button when self-portrait shooting, the mirror mode is temporarily disabled and the screen displays information such as the configuration status of all recording functions. Release the button to return to mirror mode.

- Images played back by pressing the REC CHECK button cannot be inverted horizontally.
- Operation status displays during self-portrait recording
No display: Cannot record (no card, etc.)
○: Recording in progress
□: (Red) Transitioning to recording standby mode
□: (Green) Recording standby mode
! : Warning display
- When [!] is displayed, turn the LCD monitor back in the direction of normal recording, and check what the message says.
- Holding down the DISP/MODE CHK button displays the screen display information.
- Images will be output normally to external devices. In addition, only operation status displays will appear on the screen.

Zebra pattern

Pressing the ZEBRA button in CAMERA or PHOTO mode displays zebra patterns and markers on the viewfinder and LCD monitor, allowing you to check the brightness of a subject.

Parts that may be whited out through over exposure are shown as a zebra pattern.

- Very bright
- Reflecting parts

You can remove most overexposed parts by adjusting the iris and shutter speed in the manual mode to remove the areas with zebra patterns. The display changes as follows each time you press the ZEBRA button.

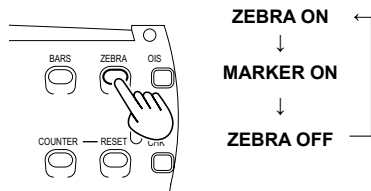

You can set brightness levels for the zebra patterns with the ZEBRA DETECT item in the setting menu SW&DISP SETUP screen. (Page 107)

The zebra pattern cannot be displayed while the focus assist function (expanded display) is in use.

Marker

If you press the ZEBRA button while zebra patterns are displayed, a marker appears near the center of the display (if you have set the setup menu, SW&DISP SETUP, MARKER to ON).

The brightness of the areas near the screen center can be checked as a percentage (0% to 99%). "99%↑" appears if the percentage is over 99.

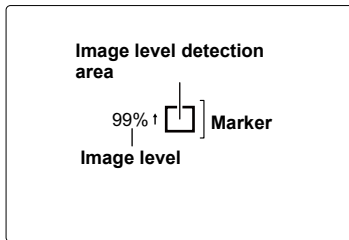

The normal display reappears if you press the ZEBRA button again.

- The marker does not appear when the face detection function is set to ON.

Checking and displaying shooting status

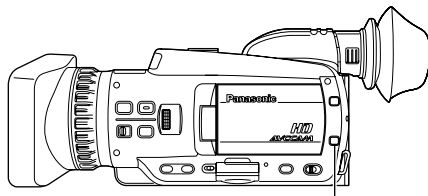

DISP/MODE CHK button

If you press and hold the DISP/MODE CHK button in recording standby mode or while recording, the configuration status of all recording functions, a list of USER button function assignments, focus ring function, and all other camera information will be displayed. Release the button to return to the normal display.

Pressing the DISP/MODE CHK button during recording or while recording is paused will remove all displays from the screen except for the operation status, counter, marker, and safety zone display. Press the button again to return to the normal display. (Page 93)

The display mode selected using the DISP/MODE CHK button is retained even if you turn off the camera by setting the POWER switch to OFF, or change the operating mode.

Shooting techniques for different targets (continued)

PRE REC

Record video and audio from three seconds before the time of the operation to begin recording.

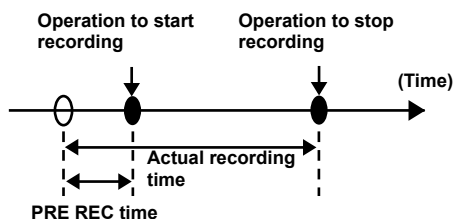

1 Touch **FREE RUN** for TCG in the setting menu **RECORD SETUP** screen.

2 Touch **ON** for **PREREC MODE** in the setting menu **RECORD SETUP** screen.

PRE-REC will be displayed on the screen.

- When the TCG item on the RECORD SETUP screen has been set to REC RUN, the setting will be automatically changed to FREE RUN.

3 Press the **START/STOP** button.

Video and audio from approximately 3 seconds previously will be recorded.

- Recording of the previous 3 seconds of video and audio may not be possible if recording is started immediately in the following cases.
 - Immediately after switching from PB mode to CAMERA mode
 - Immediately after turning power on
 - Immediately after changing to PREREC MODE item
- The thumbnail for clips recorded using the PREREC function will display the image from when the START/STOP button was pressed.
- Video from approximately 3 seconds before the button was pressed will appear in 1 clip display.

Optical Image Stabilizer

Use the Optical Image Stabilizer (OIS) to reduce the effects of camera shake when shooting by hand.

Press the OIS button to turn the function on and off. (👉) appears on the viewfinder and the LCD monitor when this function is on. Turn the function off when using a tripod for more natural images.

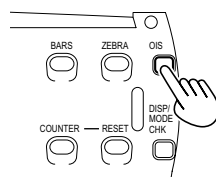

- This function will not be as effective when the vibration is severe or when tracking a moving subject.

Adding effects to images

Press the USER button you have allocated to the BLACKFADE or WHITEFADE feature to add fading effects to your images. The button's function is forcibly canceled during playback or REC CHECK and also when thumbnails are displayed.

BLACKFADE:

Press and hold to fade out to black. Audio also fades out. Fade-in starts when the button is released.

WHITEFADE:

Press and hold to fade out to white. Audio also fades out. Fade-in starts when the button is released.

Using the USER buttons

You can allocate one of 14 features to each of the three USER buttons.

Use these buttons to change shooting settings quickly or add effects to the images you are shooting.

The following features are allocated to the buttons at the time of shipping.

- USER1: (PUSH)AF
- USER2: BACKLIGHT
- USER3: SHOT MARK

For details, see the setup menus, SW&DISP SETUP screen, USER1 to 3. (Page 106)

If you press a USER button to which one of the functions has been allocated and then turn off the power, the added effect to the image will not be retained.

Backlight compensation

Press the USER button you have allocated to the BACKLIGHT feature when shooting subjects lit from the back.

BACK LIGHT appears on the screen, and  appears at the bottom right of the screen.

Backlight compensation adjusts the iris so the subject doesn't come out dark.

Press the same USER button to turn the feature off. (If you perform backlight compensation in manual iris mode and it is disabled, the camera switches to auto iris control.)

Color bars

Press the BARS button in the CAMERA mode to output a color bar screen to a television or monitor so you can adjust them. Press the button again to turn the feature off.

- While the color bar is displayed, a test tone of 1 kHz will be output from the headphone terminal, the A/V OUT terminal, or the HDMI terminal. There will be no speaker output.
- The color bar can be recorded by pressing the START/STOP button.
- The BARS button does not work in the PB mode or PHOTO mode.
- The color bar display is canceled when the power is turned off.



Wave form monitor function

During CAMERA mode, you can display a waveform for an image on the LCD monitor by pressing the USER button to which the WFM function has been assigned.



Press the button again to return to the normal display.

- Wave forms will not be displayed in the viewfinder.
- This function cannot be used while the focus assist and touch auto focus functions are enabled.
- Wave forms cannot be recorded.
- While wave forms are displayed, use the viewfinder as well since part of the recording screen will be hidden by the wave forms.

Adjusting the headphone volume while shooting

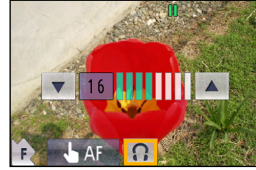
- 1 Touch the LCD monitor and display the Function Navi.
- 2 Touch  to display the operation menu.
- 3 Touch .
 - This only appears when headphones are connected.



- 4 Touch ▲ or ▼ to adjust the volume.
- 5 Touch  to close the operation menu.
- 6 Touch  to close the Function Navi.

Shot mark function

The marks attached to the thumbnails of clips are called shot marks. On the thumbnail screen monitor you can select only those clips with a shot mark and display them or play them back. During recording, when you press the USER button to which the SHOT MARK function has been allocated, MARK ON appears in the LCD monitor or the viewfinder, and a shot mark is set for the thumbnail of the clip being recorded. If you press the button again, the shot mark is released. You can also set or release the shot marks by performing the thumbnail operations for clips. (Page 69)

However, note that you cannot set or release shot marks during playback.

- INVALID appears when you cannot set or release shot marks.
- Shot marks are not displayed when the thumbnail screen is set to 20 photo display.

Shooting techniques for different targets (continued)

Interval recording

This function allows you to create short videos of scenes that move slowly over long periods of time through frame-by-frame recording at specified intervals. Single frames are recorded at the specified interval, with 24 frames equaling 1 second of video.

You can specify the interval in CAMERA mode with the INTERVAL REC item in the setting menu RECORD SETUP screen.

• **1 SECOND/10 SECONDS/30 SECONDS/1**

MINUTE/2 MINUTES: Change the recording interval.

OFF: Disable interval recording.

-  appears on the screen.
- Interval recording will be disabled when shooting is finished.
- Audio recording is disabled.
- The PRE-REC function is disabled, even if it is set.

Example	Recording interval	Shooting time	Video length
Sunsets	1 SECOND	30 min to 1 hour	1 min 15 sec to 2 min 30 sec
Butterfly emerging from cocoon	10 SECONDS	2 hr to 4 hr	30 sec to 1 min
Flowers blooming	30 SECONDS	1 hr to 3 hr	5 sec to 15 sec

- The maximum shooting time is 24 hours.
- When recording for long periods, use the AC adapter to eliminate battery concerns.

- Do not remove the battery or disconnect the AC adapter during interval recording. Doing so may damage recorded image data or result in data loss.
- When INTERVAL REC is enabled, the following setting items automatically change as follows.
REC FORMAT: PH 1080/24P
TC MODE: NDF
- When playing back a recorded video, set the playback format to 1080/24P.
- Photo shooting is disabled.
- You cannot change the recording mode while interval recording is enabled.
- Even if you have not met 24 frames when you stop recording, a 1 second video will be created.
- Depending on lighting and shooting conditions, color and focus settings may not adjust automatically. In such cases, make adjustments manually.
- The digital zoom function cannot be used while INTERVAL REC is enabled.
- The REC CHECK function does not work after interval recording.
- Clips captured with interval recording cannot be deleted with the LAST CLIP function, even if it is set.

Time stamp function

The date and time of recording can be recorded to video images.

Select ON in the TIME STAMP item on the settings menu RECORD SETUP screen.

When the TIME STAMP function is ON, the letter **R** will be displayed in front of the date and time display in the viewfinder and the LCD monitor.

In addition, the month display will change from a numerical value to an English name display.

- The letter **R** display itself will not be recorded to the video.
- The size and position of the time and date characters recorded to the image will vary depending on the recording format.
- The size and position of the timestamp characters in external output displays may vary from the displays in the LCD monitor or viewfinder.
- The recorded time and date display will follow the settings made in the DATE/TIME item on the SW&DISP SETUP screen. If this item is set to OFF, the date and time will not be recorded as a time stamp.
- To avoid date and time displays overlapping when clips with timestamps recorded are played with this camera, please set the DATE/TIME item on the SW&DISP SETUP screen to OFF.

LAST CLIP function

The most recently recorded clip can be deleted at the touch of a button by allocating the LAST CLIP function to any of the USER 1 - 3 buttons.

Press the USER button allocated for the LAST CLIP function to display YES/NO on the screen.

Select YES to delete the most recently recorded clip.

- Select NO not to delete the clip.
- If the camera has been switched to PB mode or the recording format has been changed since recording was completed, or if interval recording has completed, clips cannot be deleted even if the button is pressed. Clips also cannot be deleted if the power has been switched off and back on again.
- Clips cannot be deleted even if the button is pressed if the memory card has been removed and reinserted since recording was completed.

Adjusting the shutter speed

1 Set the AUTO/MANUAL switch to **MANUAL** to select manual mode. (Page 40)

2 Touch the LCD monitor and display the **Function Navi**.

3 Touch  to display the operation menu.

4 Touch **SHTR**.

- The shutter speed appears at the left of the screen.

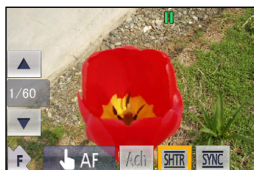

5 Touch **▲** or **▼** to adjust the shutter speed.

- As the shutter speed increases, camera sensitivity decreases.
- With auto iris control, as the shutter speed increases, the aperture widens and the focal length decreases.
- Because the focal time increases at slower shutter speeds, we recommend using a tripod.

6 Touch **SHTR** to close the operation menu.

7 Touch  to close the **Function Navi**.

- With artificial lighting and especially fluorescent lights and mercury-vapor lamps, the luminance changes in synchronization with the power line frequency. When this frequency is 50 Hz, mutual interference will occur between the camera-recorder's vertical sync frequency (approx. 60 Hz) and the lighting frequency (50 Hz). This means that the white balance may change periodically. Before shooting in areas with artificial lighting or adjusting the white balance, set the shutter speed as follows.

Progressive mode	Shutter speed	
	50 Hz	60 Hz
OFF (60i)	1/100	1/60
30P	1/50	1/60
24P	1/50	1/60

CAMERA mode:

With the 1080/60i or 720/60P formats	
Standard (1/60)	SYNCRO SCAN ↔ 1/2 ↔ 1/4 ↔ 1/8 ↔ 1/15 ↔ 1/30 ↔ 1/60 ↓ 1/2000 ↔ 1/1000 ↔ 1/500 ↔ 1/250 ↔ 1/120 ↔ 1/100 ↑
With the 1080/30P or 720/30P formats	
Standard (1/50)	SYNCRO SCAN ↔ 1/2 ↔ 1/4 ↔ 1/8 ↔ 1/15 ↔ 1/30 ↔ 1/50 ↓ 1/2000 ↔ 1/1000 ↔ 1/500 ↔ 1/250 ↔ 1/120 ↔ 1/60 ↑
With the 1080/24P or 720/24P formats	
Standard (1/50)	SYNCRO SCAN ↔ 1/2 ↔ 1/3 ↔ 1/6 ↔ 1/12 ↔ 1/24 ↔ 1/50 ↓ 1/2000 ↔ 1/1000 ↔ 1/500 ↔ 1/250 ↔ 1/120 ↔ 1/60 ↑

PHOTO mode:

Standard (1/60)	1/2 ↔ 1/4 ↔ 1/8 ↔ 1/15 ↔ 1/30 ↔ 1/60 ↔ 1/100 ↔ 1/120 ↔ 1/180 ↓ 1/2000 ↔ 1/1500 ↔ 1/1000 ↔ 1/750 ↔ 1/500 ↔ 1/350 ↔ 1/250 ↑
-----------------	--

- Under fluorescent and other discharge tube lighting, horizontal bands may appear on the display. Adjusting the shutter speed in such cases may resolve the problem.
- When shooting subjects moving quickly across the screen, the image may be distorted. This is a result of the readout method of the pickup device (MOS sensor), and is not a malfunction.
- White, red, blue, and green spots may appear on the display when using slow shutter speeds. This is not a malfunction.

Synchro scan

Adjust the shutter speed to match the frequency of the television or computer monitor to minimize the horizontal noise that appears when shooting such subjects.

- By switching to progressive mode you can also shoot PAL system television screens.
- If SYNC is displayed in grey, it cannot be used with the current recording format. This function will only operate for preset values for each recording format.

Valid setting values will appear to the right of the adjustment value.

1080/60i, 720/60P:

1/60.0 to 1/250.0 sec

1080/30P, 720/30P:

1/30.0 to 1/250.0 sec

1080/24P, 720/24P:

1/24.0 to 1/250.0 sec

1 Set the **AUTO/MANUAL** switch to **MANUAL** to select manual mode. (Page 40)

2 Touch the LCD monitor and display the **Function Navi**.

3 Touch $\overline{\text{Fn}}$ to display the operation menu.

4 Touch **SYNC**.

- The shutter speed appears at the left of the screen.

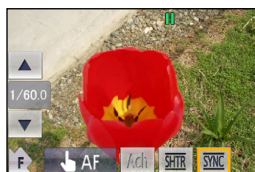

5 Touch \blacktriangle or \blacktriangledown to adjust the shutter speed for synchro scan.

6 Touch **SYNC** to close the operation menu.

7 Touch $\overline{\text{Fn}}$ to close the **Function Navi**.

-
- To activate a synchro scan setting, touch **SHTR** and switch to **SYNCRO SCAN**. (Page 51)
 - You can change the progressive mode in the setup menu with **REC FORMAT** in the **RECORD SETUP** screen. (Page 102)
-

Adjusting the mic input level

You can adjust the input level for the built-in microphone or external microphones during recording.



1 Touch the LCD monitor and display the Function Navi.

2 Touch  to display the operation menu.

3 Touch .

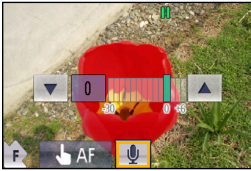
- This does not appear when MIC LEVEL SEL in the setting menu RECORD SETUP screen is set to FIX.



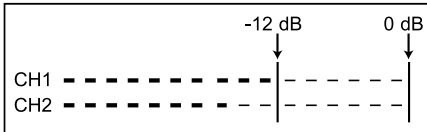

4 Touch  or  to adjust the input level.

- Use the audio level meter display to help you make adjustments.



- Check the recording volume level before shooting.

5 Touch  to close the operation menu.

6 Touch  to close the Function Navi.

-
- Stereo (2 ch) audio is enabled during external mic input.
 - You cannot eliminate audio entirely when recording.
 - When an XLR Microphone Adapter is connected, the device input is fixed and input level adjustment does not appear. Adjust the input volume on the microphone adapter to adjust the input level.
-

Using scene files

You can store various scene file setting items for different shooting conditions within a scene file. By changing scene files, you can recall necessary settings.

The following scene files are saved as the factory default settings.

Scene 1: Settings suited to standard shooting.

Scene 2: Settings suited to shooting images with modulated color hues and contrast.

Loading scene files

- 1 Set the **POWER** switch to **ON**. (Page 26)
 - The CAMERA lamp lights red.
- 2 Press the **MENU** button.
- 3 Touch **SCENE1** or **SCENE2** for **FILE SELECT** in the setting menu **SCENE FILE** screen.

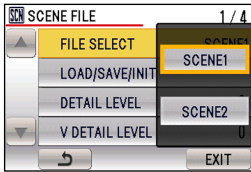

- 4 Touch **LOAD** for **LOAD/SAVE/INIT** in the setting menu **SCENE FILE** screen.

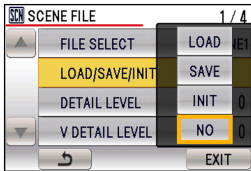

- The settings stored on the scene file will be enabled.

- 5 Touch **YES** when the confirmation message appears.
 - **SCENE1 LOADED TURN POWER OFF** appears on the screen.
 - The **SCENE1** setting is applied when you restart the camera.

- Simply changing the scene file in **FILE SELECT** will not change the settings. Be sure to perform **LOAD** with **LOAD/SAVE/INIT**. As current setting values will be changed when you perform **LOAD**, be sure to save them if necessary.

Setting and saving scene files

You can set the items found in the setting menu **SCENE FILE** screen. (Page 100)

You can save changed settings as **SCENE1** or **SCENE2**.

- 1 Set the **POWER** switch to **ON**. (Page 26)
 - The CAMERA lamp lights red.
- 2 Press the **MENU** button.
- 3 Set the items found in the setting menu **SCENE FILE** screen.
- 4 Touch **SCENE1** or **SCENE2** for **FILE SELECT** in the setting menu **SCENE FILE** screen.
- 5 Touch **SAVE** for the **LOAD/SAVE/INIT** item in the setting menu **SCENE FILE** screen when settings are finished.

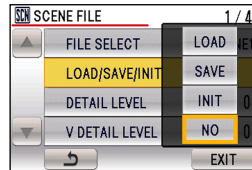

- 6 Touch **YES** when the confirmation message appears.
 - The scene file selected in the **FILE SELECT** item will be overwritten. To cancel save, touch **NO**.
 - You cannot restore scene files that have been overwritten.

Initializing scene files

You can return current setting values to their factory default settings.

- 1 Set the **POWER** switch to **ON**. (Page 26)
 - The **CAMERA** lamp lights red.
- 2 Press the **MENU** button.
- 3 Touch **SCENE1** or **SCENE2** for **FILE SELECT** in the setting menu **SCENE FILE** screen.
- 4 Touch **INIT** for **LOAD/SAVE/INIT** in the setting menu **SCENE FILE** screen.

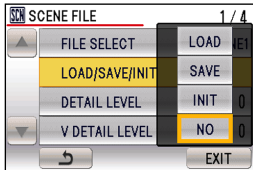

- 5 Touch **YES** when the confirmation message appears.
 - The scene file selected in the **FILE SELECT** item will be initialized.
 - “**SCENE 1 (or SCENE2) LOADED TURN POWER OFF**” appears on the screen. The default settings will be applied when you restart the camera.

Clip metadata

You can add the name of the videographer, shooting location, text memos and other information to the video data you have recorded on the SD Memory Card. This data is called the clip metadata.

Display clip metadata with the META DATA PROP item (Page 103) in the setting menu RECORD SETUP screen.

There are two kinds of clip metadata: the data that is recorded automatically during shooting, and the data in the metadata upload file created on the SD Memory Card which is loaded in the unit. (Loading method: Next page)

What the clip metadata consists of

You can set the items underlined below by loading the metadata upload file on the SD Memory Card. All other items are set automatically during shooting.

CLIP NAME:*1

This indicates the LOAD DATA (loaded data), COUNT (counter value), and REC DATA (recorded data).

ACCESS:

This indicates the CREATOR (name of the person recording) and LAST UPDATE PERSON (the person who last updated the data).

SHOOT:

This indicates the SHOOTER (name of the videographer) and the PLACE NAME (name of location).

SCENARIO:*2

This indicates the PROGRAM NAME, SCENE NO. and TAKE NO.

NEWS 1:

This indicates the REPORTER (name of the reporter) and PURPOSE (purpose of data collection).

NEWS 2:

This indicates the OBJECT (target of data collection).

MEMO1:

This indicates the PERSON (name of the person who recorded the text memo).

MEMO2:

This indicates the TEXT (contents of memo).

*1 If there is no information in the metadata upload file, consecutive five-digit numbers will be applied to the clips in the order that they were recorded, with the first clip to be recorded being given the number 0. The USER CLIP NAME recording method is selectable. Please refer to the page 57.

*2 When SCENARIO is to be input, you must input the PROGRAM NAME. You cannot input the SCENE NO. and TAKE NO. only.

-
-
- Only printable ASCII characters can be displayed by this unit.
 - Due to the limitations imposed by this unit on the number of characters which can be displayed, not all the data can be displayed. (This does not mean that the data which is not displayed has been deleted.) Use an AVCCAM viewer or other program to check all the data.
 - Metadata can be produced with AVCCAM Viewer. (Page 119)
-
-

Loading the metadata

You can perform any of the following operations. If necessary, make preparations prior to undertaking the operations.

Loading the metadata

- Insert the SD Memory Card on which the metadata is recorded into the unit. (For details on contents of the metadata, see the previous page.)

Selecting whether to record the metadata on the SD Memory Card

Initializing the metadata inside the unit

Displaying information on metadata inside the unit

- 1 Set the POWER switch to ON. (Page 26)**
 - The CAMERA lamp lights red.
- 2 Press the MENU button.**
Menu operation (Page 95)
- 3 Touch the RECORD SETUP setting menu.**
- 4 Touch ▲ or ▼ to switch pages, and select an item.**

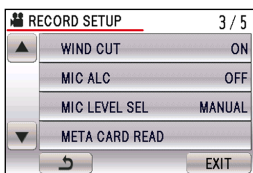

META CARD READ:

Read metadata set to the SD Memory Card with the camera.

- Up to 8 metadata files stored on the SD Memory Card (MTDT00 to MTDT07) are displayed in a list. Files with no corresponding data are displayed in gray.

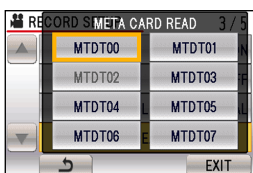

- When you touch the file you want to read, a confirmation message appears. Touch YES to read the metadata.

META DATA REC:

Select this to set whether to record the metadata to be loaded into the unit simultaneously on the SD Memory Card. Touch ON to set metadata recording.

The **META** icon appears on the LCD monitor. The factory setting for this mode is OFF.

USER CLIP NAME:

The USER CLIP NAME recording method is selectable. For details, see “Selecting the USER CLIP NAME recording method”.

META DATA PROP:

Select this to display metadata that has been loaded to the unit.

CLIP COUNTER RST:

Reset the COUNT value to 1.
Touch YES to reset.

META INITIAL SET:

Select this to initialize the metadata which has been recorded in the unit.
Touch YES to initialize.

- 5 Press the MENU button to release the menu mode.**

Selecting the USER CLIP NAME recording method

You can select the recording method for USER CLIP NAME by touching the USER CLIP NAME item in the setting menu RECORD SETUP screen. The TYPE1 and TYPE2 options are available for selection.

USER CLIP NAME to be recorded

	TYPE1	TYPE2
If clip metadata has been read in	Uploaded data	Uploaded data + COUNT value*
If no clip metadata has been read in or if the setting for recording clip metadata has been turned off	Sequential 5-digit number, in order of recording	Sequential 5-digit number, in order of recording

(Continued on the next page)

Clip metadata (continued)

* The COUNT value is indicated as a four-digit number. The COUNT value is incremented each time a new clip is captured if clip metadata has been read in and TYPE2 has been selected as the recording method.

The COUNT value can be reset using the following procedure.

Touch YES for the CLIP COUNTER RST item in the setting menu RECORD SETUP screen to reset the COUNT value to 1.

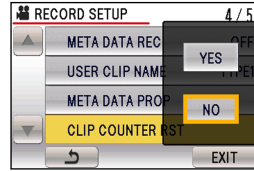

Using the Counter

Counter display

You can display a counter that indicates how much time has elapsed during shooting or playback.

1 Press the COUNTER button.

Each time you press the button, the display changes as follows. (Page 87)

0 : 00 . 00 (CAMERA mode only)

Counter value

CLIP 0 : 00 . 00

Displayed when CLIP is selected in the REC COUNTER item on the settings menu SW&DISP SETUP screen.

Values are automatically reset when recording is started, and counter values are displayed for each individual clip.

TC 12 : 34 : 56 . 01

Time code value (Display time code frame digits in 24 frames when 24P is set, and in 30 frames when any other format is set.)

UB 12 34 56 78

User information

No display:

Data is not displayed.

Resetting the counter

Press the RESET button while the counter is displayed.

Charging the built-in battery/Setting the time code

Recharging the built-in battery

The camera's internal battery saves the date and time.

When SET DATE AND TIME is displayed even when the date and time are set, it means that the charge of the internal battery is depleted. Do the following to recharge it.

Reset the date and time when fully recharged.

1 Connect the AC adapter. (Page 23)

- Leave the POWER switch at OFF.

2 Leave the camera-recorder like this for about 4 hours.

- The internal battery charges during this time.
- Check the time code and menu operations after recharging.

If the date and time are not memorized after recharging, the internal battery requires changing. Please consult the place of purchase.

Setting the time code

In the setup menus, RECORD SETUP screen, set the following time code related items. (Page 102)

- TC MODE
- TCG
- TC PRESET

Specifying the time code

Set TC PRESET so you can record a value of your choice as the initial setting for the time code to be used at the start of recording.

1 Set the POWER switch to ON. (Page 26)

2 Touch the TC PRESET item in the setting menu RECORD SETUP screen.

- Menu operation (Page 95)
- Operations may also be performed using buttons on the remote control that correspond to those on the camera. For details, see "Description of parts (Remote control)". (Page 20)

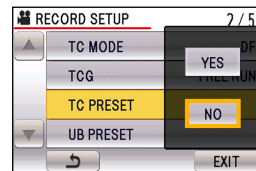

3 Touch YES.

4 Touch the item you want to set, and touch ▲ or ▼ to set the value.



You can reset the time code to zero by pressing RESET button.

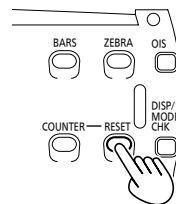

Camera

(Continued on the next page)

Charging the built-in battery/Setting the time code (continued)

5 Touch ENTER when all items have been set.

With this unit, the time code value is adjusted in accordance with the format and frame rate. For this reason, bear in mind that making a change in the format or frame rate may result in discontinuity from the last time code value of the previous recording.

Recording format	Time code adjustment
1080/24P	Adjustable in 4-frame increments
720/24P	

Setting user information

Setting user information allows you to store 8-digit information in the hexadecimal format.

User information is automatically saved in the memory and retained after you turn off the power.

1 Set the POWER switch to ON. (Page 26)

2 Touch the UB PRESET item in the setting menu RECORD SETUP screen.

- Menu operation (Page 95)
- Operations may also be performed using buttons on the remote control that correspond to those on the camera. For details, see "Description of parts (Remote control)". (Page 20)

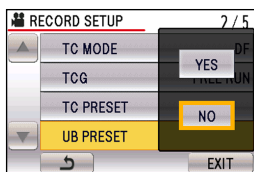

3 Touch YES.

4 Touch the item you want to set, and touch ▲ or ▼ to set the value.

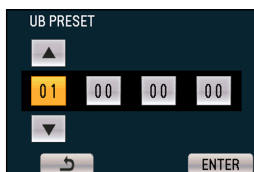

You can reset the user information to nothing by pressing RESET button.

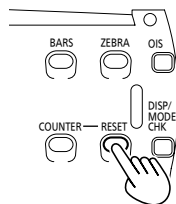

Camera

5 Touch ENTER when all items have been set.

Shooting photos

1 Set the POWER switch to ON. (Page 26)

- The CAMERA lamp lights red.

2 Lower and hold the POWER switch.

- The PHOTO lamp lights red.

3 Press the REC CHECK/PHOTO button halfway.

- During auto focus, a shutter chance mark and focus frame appear and focus is aligned. During manual focus, only the focus frame appears.

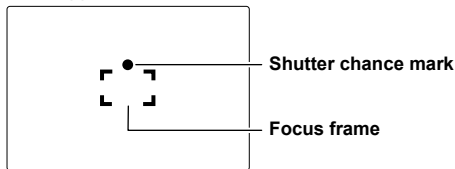

- Shutter chance mark
 - (Flashing white): Focusing in progress.
 - (Lit green): Focusing complete.
 - No mark: Focusing incomplete.

4 Press the REC CHECK/PHOTO button fully.

- Audio recording is disabled.
- If you press the REC CHECK/PHOTO button fully without first pressing it halfway, it may take longer to record the photo.
- As the shutter speed decreases in dark conditions, we recommend using a tripod or flash.
- If the shutter speed is 1/30 sec or below, the screen will be dark while the START/STOP button is pressed halfway.

■ Screen displays during photo shooting

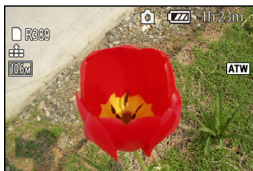

- : Operation mode status
- : Remaining battery display
- : Quality
- : Recording pixels
- R389** : Remaining media capacity (flashes red when "0" is reached)
- : AWB information display

- For details on other screen displays, see "Screen displays". (Page 86)

■ Shutter chance mark

- The shutter chance mark does not appear in manual focus mode.
- The shutter chance mark may not appear if the following occur.
 - High zoom ratio
 - Excessive camera shake
 - Moving subjects
 - Backlight
 - Nearby and far away objects coexist in the frame
 - Low lighting or dark conditions
 - Bright areas in the frame
 - Subjects consisting entirely of horizontal lines
 - Conditions with low contrast

■ Focus frame

If the focus does not align, perform the following.

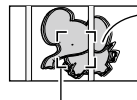

The focus aligns on an object with high contrast (such as a fence) and the subject is blurred.

Focus frame

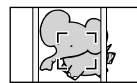

The focus will align if you reposition the center of focus. Shift the center of focus.

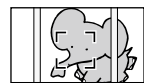

OR Zoom in or move closer to the subject.

- The focus frame will not appear in the following case.
 - While face detection frames are displayed during auto face detection shooting mode.

Shooting photos (continued)











Setting the aspect ratio / recording pixels

You can select an aspect ratio based on the your intended print or playback method. In addition, the higher the recording pixel setting, the sharper your printed images will appear.

Set the aspect ratio with the ASPECT RATIO item in the setting menu PICTURE screen.

Set the recording pixels with the PICTURE SIZE item in the setting menu PICTURE screen.

■ Recording pixels

Aspect ratio	Recording pixels	
4:3		3520×2640
		3264×2448
		2560×1920
		640×480
3:2		3984×2656
		3264×2176
		2592×1728
16:9		4224×2376
		3328×1872
		2560×1440

- If you set the aspect ratio to 4:3 or 3:2, black bars will appear on the left and right edges of the screen.
- When you print photos recorded with this camera in 16:9 aspect ratio, the edges may be cut off. Be sure to check beforehand when printing at a store or with other printers.
- The recording pixel settings that are available vary depending on the selected aspect ratio.
- Recording may take longer with higher recording pixel settings.
- The maximum zoom ratio is x 12.

Setting the picture quality









You can select the quality for recorded pictures. Set the picture quality with the QUALITY item in the setting menu PICTURE screen.

 : Record photos with high image quality.







 : Prioritize quantity, and record photos with standard image quality.

- When shooting with QUALITY set to , photos may appear blurry depending on the subject.







Maximum number of photos



Aspect ratio		4:3							
Recording pixels		9M 3520×2640		8M 3264×2448		5M 2560×1920		0.3M 640×480	
Quality									
SD Memory Card capacity	8 MB	0	0	0	1	1	2	33	52
	16 MB	1	3	2	3	3	6	77	120
	32 MB	3	6	4	7	7	13	145	220
	64 MB	9	15	11	18	19	31	330	510
	128 MB	20	32	23	38	39	62	650	1010
	256 MB	44	70	51	81	84	135	1380	2150
	512 MB	89	140	105	165	170	270	2760	4300
	1 GB	180	290	210	330	340	540	5550	8660
	2 GB	370	590	430	680	700	1110	11320	17650
	4 GB	730	1150	850	1340	1390	2180	22250	34710
	6 GB	1110	1750	1300	2040	2110	3310	33850	52800
	8 GB	1490	2350	1740	2730	2820	4440	45310	70690
	12 GB	2250	3540	2620	4120	4260	6690	68370	106650
16 GB	3010	4720	3500	5490	5680	8930	91200	142280	
32 GB	6030	9480	7010	11020	11400	17920	182990	285460	

Shooting

Aspect ratio		3:2					
Recording pixels		10.6M 3984×2656		7M 3264×2176		4.5M 2592×1728	
Quality							
SD Memory Card capacity	8 MB	0	0	0	1	1	2
	16 MB	1	2	2	4	4	7
	32 MB	3	5	5	6	8	14
	64 MB	8	13	13	21	21	34
	128 MB	17	28	26	42	43	68
	256 MB	38	61	58	92	93	145
	512 MB	78	125	115	185	185	300
	1 GB	160	250	240	380	380	600
	2 GB	330	510	490	770	770	1210
	4 GB	640	1010	960	1510	1520	2390
	6 GB	980	1540	1460	2290	2310	3640
	8 GB	1310	2060	1950	3070	3100	4870
	12 GB	1980	3110	2950	4630	4670	7340
16 GB	2640	4150	3930	6180	6240	9800	
32 GB	5300	8320	7890	12400	12510	19660	

Shooting photos (continued)

Aspect ratio		16:9					
Recording pixels		10M 4224×2376		6M 3328×1872		3.5M 2560×1440	
Quality							
SD Memory Card capacity	8 MB	0	0	0	1	1	3
	16 MB	1	2	2	5	5	9
	32 MB	3	5	6	10	10	17
	64 MB	8	14	15	24	26	41
	128 MB	18	30	30	49	52	83
	256 MB	41	65	66	105	115	180
	512 MB	83	130	135	210	230	360
	1 GB	170	270	270	430	460	720
	2 GB	340	540	560	870	940	1480
	4 GB	680	1070	1090	1720	1850	2900
	6 GB	1030	1620	1660	2610	2810	4420
	8 GB	1380	2170	2230	3500	3770	5910
	12 GB	2090	3280	3360	5280	5680	8920
16 GB	2780	4370	4480	7050	7580	11910	
32 GB	5580	8780	9000	14140	15210	23890	

- The maximum number of photos may vary if both  and  quality photos are recorded or depending on the subject.
- The maximum display for the remaining number of photos that can be recorded is 99999.
If the remaining number of photos that can be recorded is greater than 99999, the display will remain the same until the remaining number of photos is below 99999.

Thumbnail screen

Video data recorded in CAMERA mode is referred to as a clip, while still image data recorded in PHOTO mode is referred to as a photo. When you enter PB mode, thumbnail images of clips or photos appear on the LCD monitor (The thumbnails may take longer to display with higher quantities of clips and photos.). You can perform the following operations using the thumbnail screen.

- Play and delete clips or photos
- Format SD Memory Card
- Add or delete shot mark

During clip playback

Press the T (+) and W (-) zoom buttons (or zoom lever) to change the display of the thumbnail screen in the following sequence.

20 clip display ← 9 clip display (default) ← 1 clip display → Clip properties display

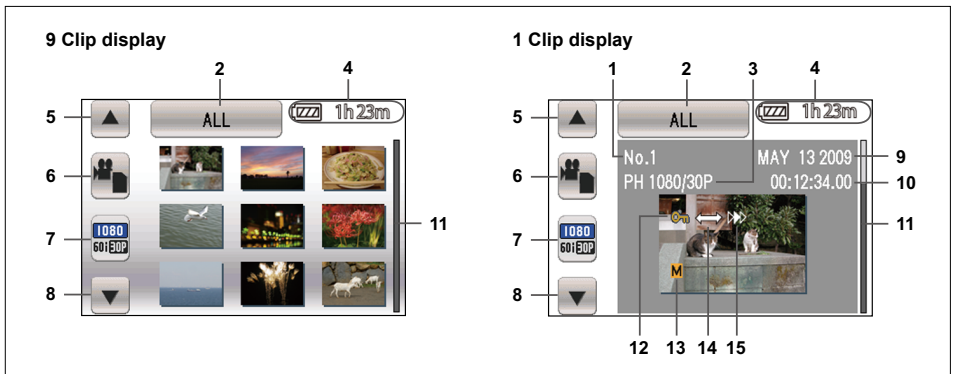

1 Clip number

Displays in the order recorded. Clips with invalid recording formats and other clips that cannot be played back will be displayed with red numbers (during 1 clip or clip properties display) or red frames (during 9 clip or 20 clip display). To play back clips displayed in red, touch the icon for changing playback format, and change the format.

2 Thumbnail mode selection

Selects the thumbnail mode. (Page 67)

3 Recording format display

Displays the recording format.

4 Remaining battery display

Displays the remaining battery capacity.

5 Back

Displayed when there is a large quantity of clips. Displays the previous page of the thumbnail screen or previous clip.

6 Video/photo selection

Selects whether to display the clip or photo thumbnail screen.

7 Playback format selection

Selects the playback format. (Page 73)

8 Next

Displayed when there is a large quantity of clips. Displays the next page of the thumbnail screen page or next clip.

9 Date display

Displays the date of recording.

10 Duration display

Displays the duration.

11 Scrollbar

Displayed when there is a large quantity of clips. Allows you to scroll the screen.

12 Clip protect mark

Indicates protected clips. (Page 78)

13 Shot mark

Indicates that a shot mark has been added. (Page 69)

14 Interval recording mark

Indicates clips that were recorded with interval recording. (Page 48)

15 Resume playback mark

Indicates clips that will resume playback from a previous point. (Page 73)

- If "⏮" appears on a thumbnail, the clip cannot be played back.

Thumbnail screen (continued)

During photo playback

Press the T (+) and W (-) zoom buttons (or zoom lever) to change the display of the thumbnail screen in the following sequence.

20 photo display ← 9 photo display (default) ← 1 photo display

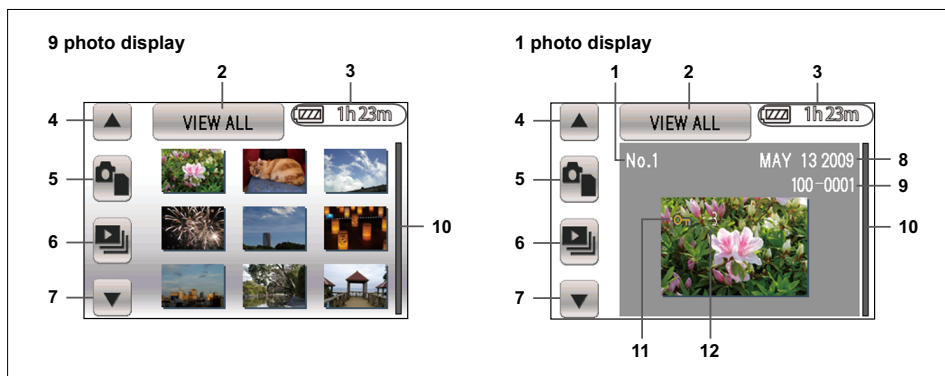

1 Photo number

Displays in the order recorded.

2 Date selection

Use to select photos to display by date.

3 Remaining battery display

Displays the remaining battery capacity.

4 Back

Displayed when there is a large quantity of photos. Displays the previous page of the thumbnail screen or previous photo.

5 Video/photo selection

Selects whether to display the clip or photo thumbnail screen.

6 Slideshow

Use to perform slideshow playback. (Page 75)

7 Next

Displayed when there is a large quantity of photos. Displays the next page of the thumbnail screen or next photo.

8 Date display

Displays the date of recording.

9 Photo folder/filename display

Displays the folder/filename for the photo.

10 Scrollbar

Displayed when there is a large quantity of photos. Allows you to scroll the screen.

11 Scene protect mark

Indicates protect photos. (Page 78)

12 DPOF settings mark

Indicates photos that include DPOF settings. (Page 79)

- If "P" appears on a thumbnail, the photo cannot be played back.

Thumbnail operations

Selecting the thumbnail display method

■ During clip playback

You can display the kind of clips you want to see as thumbnails.

You can also set more precisely how you want the thumbnails to appear on the screen.

1 Touch [Thumbnail mode selection] in the thumbnail screen.

Thumbnail mode selection

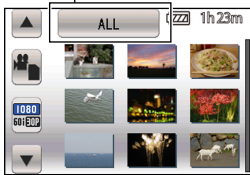

2 Touch the type of clips to display. THUMBNAIL MODE:

Select the clips to be displayed.

ALL:

Display all clips.

SAME FORMAT:

Display all clips of the same format as the current PB format.

MARKER:

Display all clips with shot marks.

■ During photo playback

You can display thumbnails by the date on which the photos were recorded.

1 Touch [Select date].

Select date

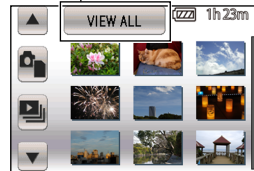

2 Touch a recording date for the photos. Date list:

VIEW ALL:

Display all photos.

Date:

Display photos recorded on the specified date.

Format card and card information

SD Memory Cards can be formatted, and SD Memory Card information can be checked.

1 Press the MENU button.
Menu operation (Page 95)

2 Touch the OTHER FUNCTIONS setting menu.

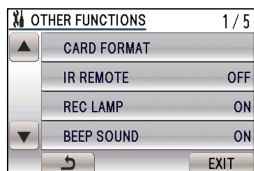

CARD FORMAT:

- Insert card to be formatted into the camera.
- SD Memory Card will be formatted.
Touch YES to proceed with formatting.

CARD STATUS:

Displays information on the SD Memory Card. Touch YES to display.

3 Touch EXIT to return to the thumbnail screen.

SD Memory Card information screen

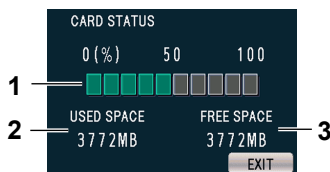

1 Remaining capacity:

Displays the remaining SD Memory Card capacity.

2 USED SPACE:

Displays the amount of SD Memory Card capacity used.

3 FREE SPACE:

Displays the amount of SD Memory Card capacity free.

Confirming clip information

You can confirm and view information related to clips.

Press the T (+) zoom button (or zoom lever) while displaying the thumbnail screen to display clip properties.

Clip information screen

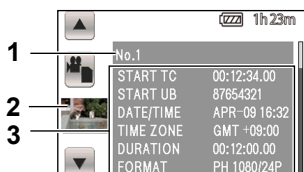

1 Clip number

2 Thumbnail (Thumbnail screen: Page 65)

3 Clip information

Displays indicators attached to clip, and various other information.

START TC: Time code value at start of recording

START UB: User information value at start of recording

DATE/TIME: Date of recording at time at start of recording

TIME ZONE: Displays time zone.

DURATION: Clip length

FORMAT: Recording format

Adding a SHOT MARK to a clip

Adding a SHOT MARK (M) will make it easier to find the clips you are looking for.

1 Press the T (+) zoom button (or zoom lever) to change the thumbnail screen to 1 clip display.

2 Touch ▲ or ▼ to select the clip for which a SHOT MARK will be added.

3 Press the USER button to which the SHOT MARK function has been allocated. (Page 106)

To remove a SHOT MARK, repeat the above steps.

- It is not possible to add shot marks to clips recorded using a consumer camcorder model.

Playing back clips

Thumbnail screen

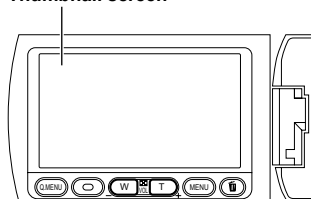

1 Set the POWER switch to ON. (Page 26)

- The CAMERA lamp lights red.

2 Lower the POWER switch.

- The PB lamp lights green.

3 Touch [Video/photo selection], and select videos.

Video/photo selection

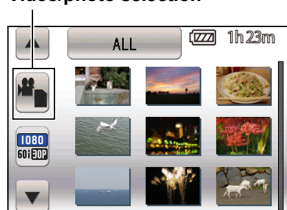

4 Touch the clip you want to play back.

- Touch ▲ or ▼ to display the next (or previous) page.

5 Touch the operation icons to operate playback.



Operation icons

▶/	Play/pause
◀◀ (◀)	Fast reverse playback (slow reverse playback)
▶▶ (▶)	Fast forward playback (slow motion playback)
■	Stop playback and return to thumbnail screen
▷	Display direct playback bar (Page 72)

- The operation icons disappear after about 3 seconds without operation. Touch the screen to display them again.

■ Changing the thumbnail screen display

Press the T (+) and W (-) zoom buttons (or zoom lever) while thumbnails are displayed, to change the display of the thumbnail screen in the following sequence.

20 clip display ↔ 9 clip display ↔ 1 clip display ↔ Clip properties display



- The display returns to 9 clip display when you turn off the camera or switch modes.
- You can also perform the same operation with the zoom lever.

-
- Clips that are displayed in the thumbnail screen with a red frame or red number cannot be played back due to the playback format being incorrect. Change the playback format. For details, see "Set playback format". (Page 73)
 - An SD Memory Card on which 1,000 or more clips are recorded becomes a dedicated playback card, and the clips cannot be deleted. To delete a clip, use the dedicated AVCCAM Viewer. (Page 119)
-

■ Adjusting the volume

Adjust the speaker/headphone volume during playback using the zoom buttons.

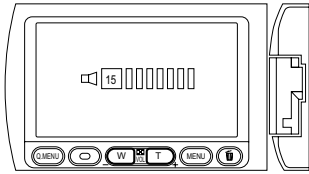

+ : Raise the volume

- : Lower the volume

■ Fast reverse/forward playback

Touch ►► during playback for fast reverse playback (◀◀ for fast forward playback).

- If you touch these again, the playback speed will increase. (The screen display will change from ►► to ►►►.)
- Touch ►/|| to return to normal playback.

■ Skip playback (clip selection)

(wireless remote control operation only)

- 1) Press the PAUSE button during playback to pause the clip.
- 2) Press the ◀◀ or ►► button on the remote control.

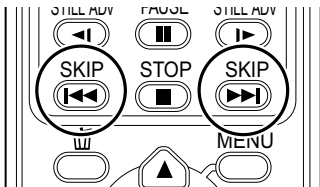

- The screen will return to the thumbnail display when moving beyond the beginning of the first clip or the end of the final clip.

■ Slow motion playback

- 1) Pause playback.
Keep the operation icons displayed.
 - 2) Touch and hold ||► (◀|| for reverse slow playback).
Slow playback will continue for as long as you touch the icon.
- Touch ►/|| to return to normal playback.
 - In reverse slow playback, video is played back frame-by-frame (0.5 second interval) at 2/3 the speed of normal playback.

■ Frame-playback

You can perform frame-by-frame playback for videos.

- 1) Pause playback.
Keep the operation icons displayed.
- 2) Touch and release ||► quickly (◀|| for reverse slow playback).
 - Touch ►/|| to return to normal playback.
 - Frames are played back at 0.5 second intervals during reverse frame playback.
 - Hold down to continuously advance frame by frame until the button is released.
 - Hold down the STILL ADV button on the remote control to continuously advance frame by frame. Press the PAUSE button to cancel.

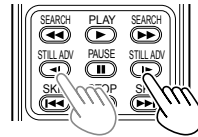

When the ► button is pressed, the images are advanced in the forward direction, and when the ◀ button is pressed, they are advanced in the reverse direction at half-second intervals.
To return to normal playback, press the PLAY button.

Playing back clips (continued)

■ Direct playback

- 1) Touch ▷ to display the direct playback bar.
- 2) Touch the direct playback bar.



Direct playback bar

- The playback images will skip in a paused state to the position that you touch.
- Playback will begin when you release the playback bar.
- Touch ◀ to display the operation icons.
- The direct playback bar will disappear after about 3 seconds without operation. Touch the screen to display it again.
- The direct playback bar cannot be operated with the remote control.

Video compatibility

- This camera supports the AVCHD format.
- This camera can play back the following video signal types:
1920×1080/60i, 1920×1080/30p, 1920×1080/24p,
1440×1080/60i, 1280×720/60p, 1280×720/30p,
and 1280×720/24p.
- Video recorded with other AVCHD-compatible devices may not play back properly on this camera. Similarly, video recorded with this camera may not play back properly on other devices.

-
-
- Audio is only included in normal playback.
 - The display will return to the thumbnail screen if playback is left paused for more than 5 minutes.
 - Thumbnails that appear as ! cannot be played back.
 - Closing the LCD monitor does not turn the camera off.
 - During counter display, the time display for playback will return to "0h00m00s" at the beginning of each clip.
-
-

Clip playback settings

Make settings for playback format and method.

Set playback format

Set format for playback.

- 1 Touch [Playback format selection] in the thumbnail screen.

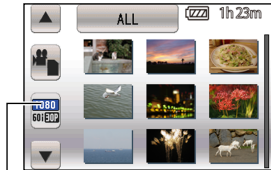

Playback format selection

- 2 Touch the playback format.
 - Available playback formats: 1080/60i(30P), 1080/24P, 720/60P(30P), 720/24P
 - Under default settings, the setting for the REC FORMAT item in the setting menu RECORD SETUP screen will be applied.
 - Clips that cannot be played back will be displayed with red numbers or framed in red.

Even if the playback format is changed, the format set in the REC FORMAT item on the settings menu RECORD SETUP screen will be restored when the camera is switched to CAMERA mode.

Repeat playback

Use this setting to repeatedly play back all available clips.

- 1 Press the MENU button.
Menu operation (Page 95)
- 2 Set the REPEAT PLAY item in the PLAY SETUP screen to ON.
- 3 Touch EXIT to return to the thumbnail screen.
When the playback operation is performed, the playable clips are played back repeatedly.
 - Repeat playback will continue until playback is paused.
 - When REPEAT PLAY is set to ON,  appears on the playback screen.
 - To turn the repeat playback setting off, select OFF in step 2.

Resume playback (RESUME PLAY)

Use this setting to play back from where clip had previously been paused.

- 1 Press the MENU button.
Menu operation (Page 95)
- 2 Set the RESUME PLAY item in the PLAY SETUP screen to ON.
- 3 Touch EXIT to return to the thumbnail screen.
- 4 Select a clip for playback.
If playback has previously been paused, the resume playback indicator will be displayed on the clip thumbnail, and the remainder of the clip will be played next time the clip is selected for playback.
 - To turn the resume playback setting off, select OFF in step 2.

Playing back photos

Thumbnail screen

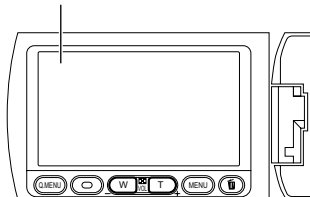

- 1 Set the POWER switch to ON. (Page 26)**
 - The CAMERA lamp lights red.
- 2 Lower the POWER switch.**
 - The PB lamp lights green.
- 3 Touch [Video/photo selection], and select photos.**

Video/photo selection

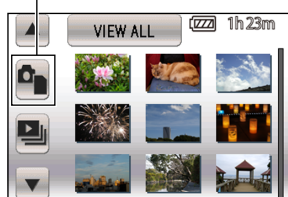

- 4 Touch the clip you want to play back.**
 - The selected photo appears in full-screen display, and operation icons appear automatically.
 - Touch ▲ or ▼ to display the next (or previous) page.

- 5 Touch the operation icons to operate playback.**

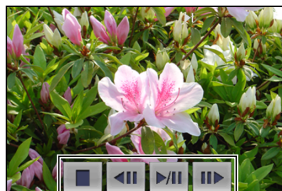

Operation icons

▶/	Start/pause slideshow playback
◀◀	Play back previous photo
▶▶	Play back next photo
■	Stop playback and return to thumbnail screen

- The operation icons disappear after about 3 seconds without operation. Touch the screen to display it again.

■ Changing the thumbnail screen display

Press the T (+) and W (-) zoom buttons (or zoom lever) while thumbnails are displayed, to change the display of the thumbnail screen in the following sequence.

20 photo display ← → 9 photo display ← → 1 photo display



- The display returns to 9 photo display when you turn off the camera or switch modes.
- You can also perform the same operation with the zoom lever.

■ Changing slideshow settings in PB mode

1) Touch [Slideshow].



Slideshow

2) Touch an interval duration.

- SHORT: Approx. 1 second
- NORMAL: Approx. 5 seconds
- LONG: Approx. 15 seconds

3) Touch a background music selection.

- Use the zoom buttons to adjust the volume for music during slideshow playback or music check.
- To check the music, touch START.
- To check another music selection, touch it on the LCD monitor.
- Touch STOP to stop music playback.

4) Touch ENTER.

-
- Thumbnails that appear as ! cannot be played back.
-

Photo compatibility

- This camera complies with DCF (Design rule for Camera File system) specifications established by JEITA (Japan Electronics and Information Technology Industries Association).
- This camera can play back JPEG-format photo files. (Playback is not guaranteed for all JPEG files.)
- Photos recorded/created with other devices may not play back properly on this camera. Similarly, photos recorded with this camera may not play back properly on other devices.

Playback by date

This function selects only photos shot on a specified date for playback.

1 Touch [Select date].

Select date

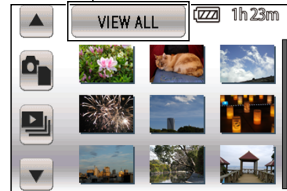

2 Touch the date on which the photos for playback were shot.

Thumbnails for only the photos shot on that date appear.

3 Touch the photo with which to start playback.

-
- The display returns to full-screen playback when you turn off the camera or switch modes, and then switch to photo playback again.
 - If the number of photos shot on the same date exceeds 999, the photos will be displayed separately.
-

Useful playback functions

Adjust volume (remote control)

- 1 **Adjust the audio output of the built-in speaker and headphones during playback.**
Press the ZOOM/VOL buttons.

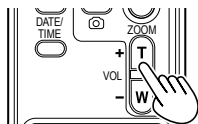

Viewing images on a television

You can view the images on a television if you connect the unit to a TV set using an AV cable (included), HDMI cable (not included) or component video cable (included).

- 1 **Connect the camera-recorder to the TV set.**
(Page 84)

- 2 **Start playback.**

- To show the information that appears on the viewfinder and LCD on a television, press the EXT. DISPLAY button on the remote control.
Press the EXT. DISPLAY button again to clear the display.

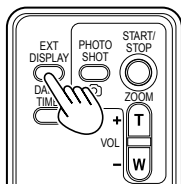

Checking the date and time

Press the DATE/TIME button on the remote control to show the date and time of shooting on the viewfinder and the LCD monitor. The display changes as follows each time you press the button.

Time
↓
Date
↓
Time and Date
↓
No display

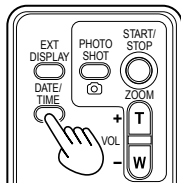

Deleting clips/photos (videos and photos)

- Clips and photos that are deleted cannot be restored. Be sure to check carefully before deleting them.

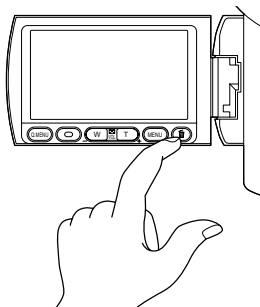

To delete while viewing recorded data
Press the  button while playing back the clip or video to delete.

- Touch YES when the confirmation message appears.

Deleting multiple clips or photos simultaneously

1 Press the  button while the clip or photo thumbnail screen is displayed.

2 Touch ALL CLIPS.

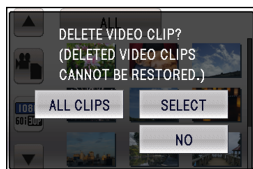

- When you select ALL CLIPS or ALL SCENES, all clips or photos stored on the SD Memory Card will be deleted. Touch YES when the confirmation message appears. (During playback by date, only the clips and photos recorded on the selected date will be deleted.)
- Touch CANCEL to cancel deletion procedures in progress.
- Clips and photos that are protected will not be deleted.

3 Press the MENU button when deletion is finished.

Selecting clips or photos to delete

1 Press the  button while the clip or photo thumbnail screen is displayed.

2 Touch SELECT.

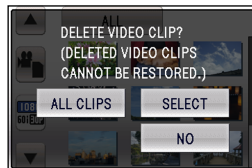

3 Touch the clips or photos to delete.

- Touched clips and photos will be selected, and the  icon will appear. To cancel a selection, touch the clip or photo again.
- You can select up to 99 clips or 99 photos.
- Clips and photos that are protected will not be deleted.

4 Touch DELETE, or press the  button.

- Touch YES when the confirmation message appears.
- Touch CANCEL to cancel deletion procedures in progress.

5 Press the MENU button when deletion is finished.

- You can also perform deletion using menu operations.
For clips:
Touch the DELETE item in the setting menu OPERATION screen.
For photos:
Touch the DELETE item in the setting menu PICT. SETUP screen.
- Thumbnails that appear as  cannot be deleted.
- The deletion procedure may take longer when deleting large numbers of clips or photos.
- Be sure that the battery is sufficiently charged or use the AC adapter when deleting data.
- When using this camera to delete clips or DCF-compliant photos shot with other devices, all related data may also be deleted.
- When deleting photos that were shot with other devices and stored on an SD Memory Card, even files that cannot be played back on this camera (non-JPEG files) may be deleted.
- When you select ALL CLIPS or ALL SCENES, all clips or photos stored on the SD Memory Card will be deleted.

Setting protection (videos and photos)

You can set protection for clips and photos to prevent accidental deletion. **(Even protected data will be deleted if you format the memory.)**

Protecting clips

- 1 Press the **MENU** button while the clip thumbnail screen is displayed.
- 2 Touch **YES** for the **CLIP PROTECT** item in the setting menu **OPERATION** screen.



- 3 Touch the clips to protect.
 - **On** appears for touched clips. Touch again to release protection.
 - Touch **RETURN** or press the **MENU** button when protection settings are finished.

-
- Executing a format of the memory will delete clips even if they are protected.
-

Protecting photos

- 1 Press the **MENU** button while the photo thumbnail screen is displayed.
- 2 Touch **YES** for the **SCENE PROTECT** item in the setting menu **PICT. SETUP** screen.

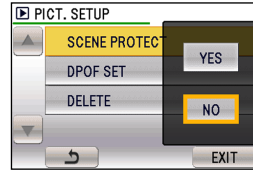

- 3 Touch the photos to protect.
 - **On** appears for touched scenes. Touch again to release protection.
 - Touch **RETURN** or press the **MENU** button when protection settings are finished.

-
- Executing a format of the memory will delete photos even if they are protected.
-

DPOF settings (photos)

Information (DPOF data) such as which photos to print and the number of copies to print can be written to the SD Memory Card.

- 1 Press the **MENU** button while the photo thumbnail screen is displayed.
- 2 Touch **SET** for the **DPOF SET** item in the setting menu **PICT. SETUP** screen.

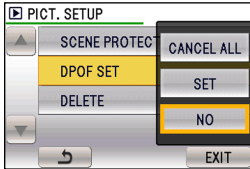

- 3 Touch the photo to set the number of copies to print.



- You can set the number to between 0 and 999 copies. (You can print the specified number of copies on DPOF-compatible printers.)
- To cancel the setting, set the number to 0.

- 4 Touch **ENTER**.
- Configure DPOF settings for other photos.
 - Press the **MENU** button when DPOF settings are finished.

■ Canceling all DPOF settings

Touch **CANCEL ALL** for the **DPOF SET** item in the setting menu **PICT. SETUP** screen.

- Touch **YES** when the confirmation message appears.

■ What is DPOF?

DPOF stands for Digital Print Order Format. DPOF allows you to write print information onto the memory card for use on a DPOF-compatible system.

-
-
- You cannot specify date printing with DPOF settings.
-
-

Printing photos on a printer (PictBridge)

- A PictBridge-compatible printer is necessary. (Refer to the operating instructions for the printer.)

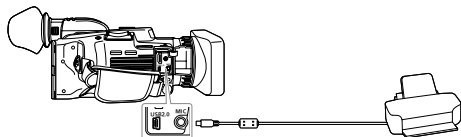

USB connection cable (optional)

1 Set the POWER switch to ON. (Page 26)

2 Connect the camera to the printer.

The USB function select screen appears.

- Connect the camera to the printer directly, and do not use a USB hub.
- Use the AC adapter to eliminate battery concerns.

3 Touch [PRINTER].



4 Touch the photo to print.

5 Touch ▲ or ▼ to set the number of copies to print.

- You can set up to 9 copies to print.
- To cancel the setting, set the number to 0.
- You can set up to 999 different photos to print.

6 Touch ENTER.

7 Touch [Tool].



Tool

8 Select whether to print the date.

- This is only available for printers that support date printing.

9 Select the print size.

STANDARD : Standard size set for the printer

4X5 INCH : 4X5 inch size

5X7 INCH : 5X7 inch size

4X6 INCH : 4X6 inch size (postcard)

A4 : A4 size

- You cannot select print sizes that are not supported by the printer.

10 Select the layout.

STANDARD : Standard layout set for the printer

 : Prints without frames

 : Prints with frames

- You cannot select layouts that are not supported by the printer.

11 Touch ↵.

12 Touch [Printer] to print.

Printer

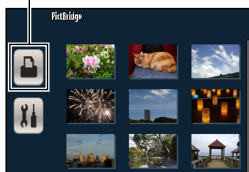

- Touch the start button when the confirmation message appears.

- To cancel printing, touch CANCEL. A confirmation message appears.

YES:

Clear print settings, and return to step 4.

NO:

Keep print settings, and return to step 4.

- PictBridge will close when you disconnect the USB connection cable (optional) after printing finishes.

-
-
- To prevent printing errors, do not do the following while printing is in progress.
 - Disconnect the USB connection cable
 - Open the card cover and remove the SD Memory Card
 - Change modes
 - Turn the power off

- When you print photos recorded with this camera in 16:9 aspect ratio, the edges may be cut off.

If the printer supports functions such as trimming and printing without frames, try clearing these settings before printing. (Refer to the operating instructions for the printer.)

- When the camera is connected to a printer, DPOF printing is disabled.
-
-

Connecting external units

Headphones

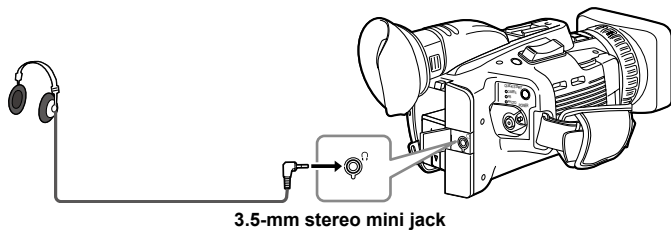

- Sound is no longer heard from the speaker when the headphones (optional) are connected.

External microphone (Stereo mini jack compatible)

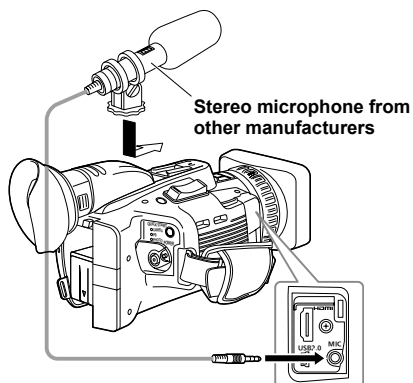

External microphone (XLR Microphone Adapter (optional) compatible)

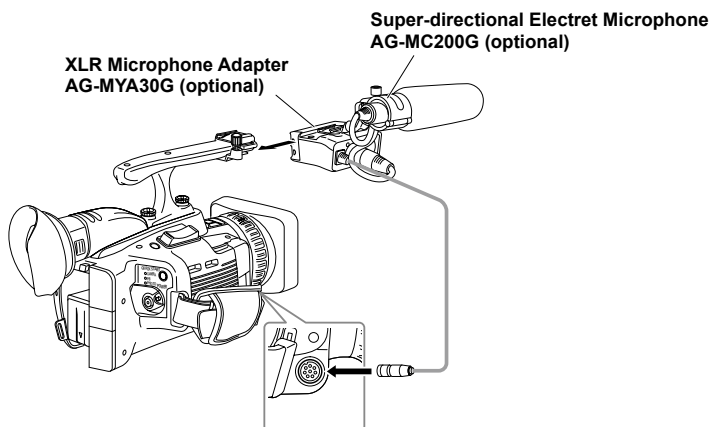

- When an external microphone is connected to both the stereo mini jack and the XLR Microphone Adapter, the XLR Microphone Adapter is given priority.

Computer (non-linear editing/file transfer)

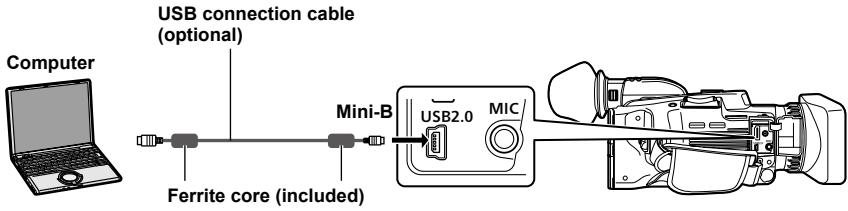

- For details on the computer's conditions and other factors, see page 85.
- When connecting the camera with a PC using a USB connection cable, attach the two ferrite cores (included) to the USB connection cable, one at a position about 5 cm from the PC terminal and the other at a position about 5 cm from the camera terminal. After attaching the cable as shown in the diagram on the right, close the terminal so that it clicks and locks into place.
- Always take sufficient care when handling the ferrite core, as it can be easily damaged when dropped or subjected to other impact.
- Please use a USB connection cable that is shielded and no more than 3 meters long.

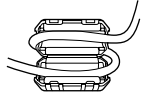

Video deck (Dubbing)

Video and audio output will be limited to that from the camera.

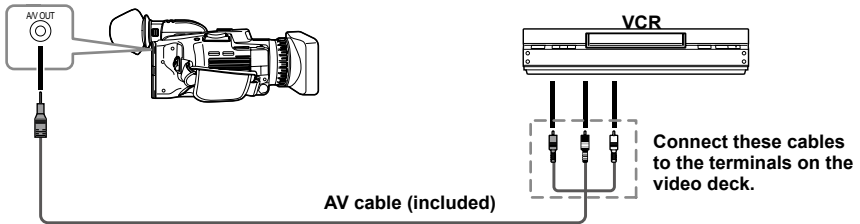

- When outputting video and audio signals from the camera to an external device, connect to the input terminals of the external device.

Connecting external units (continued)

TV/Monitor

Only the output signals from the camera are shown.

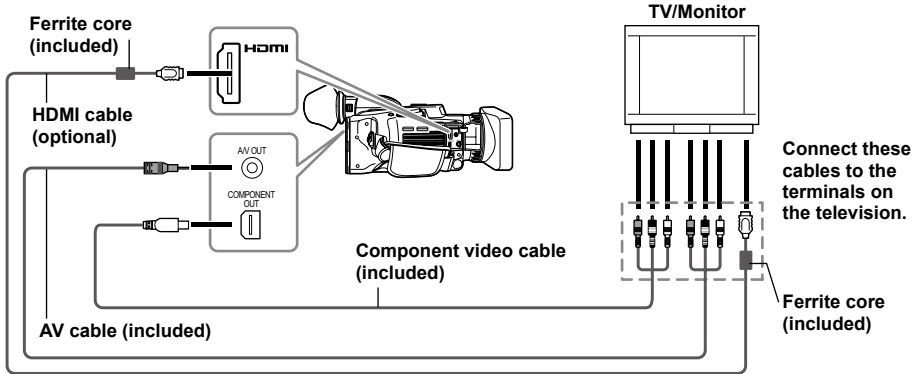

■ When outputting video and audio signals from the camera to an external device, connect to the input terminals of the external device.

- When connecting the camera with a TV/monitor using an HDMI cable, attach the two ferrite cores (included) to the HDMI cable, one at a position about 5 cm from the TV/monitor terminal and the other at a position about 5 cm from the camera terminal. After attaching the cable as shown in the diagram on the right, close the terminal so that it clicks and locks into place.
- If the ferrite core moves along the cable and cannot be fixed in place, please attach cable ties to either side of the ferrite core to ensure that it remains fixed.

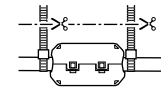
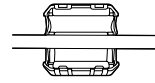

- Adjust the length of the ties by cutting with scissors, etc.
- Always take sufficient care when handling the ferrite core, as it can be easily damaged when dropped or subjected to other impact.
- It is recommended that you use Panasonic's HDMI cable.
- HDMI output will take priority if both HDMI cable and VIDEO OUT cable are connected at the same time. Simultaneous output is not possible.
- This product is not compatible with VIERA Link.
- When connecting the camera to another device using the component video cable, if the terminal on the device to which it is to be connected is a BNC type, use the pin-BNC conversion plug provided.

■ Output by HDMI output, COMPONENT OUT, and A/V OUT

When an HDMI cable is connected simultaneously with a COMPONENT cable or an AV cable, priority for output is given in the order HDMI > COMPONENT OUT > A/V OUT. (Simultaneous output is not possible.)

Nonlinear editing

Non-linear editing of video data on SD Memory Cards can be performed by connecting the camera via the USB connection cable to a computer for editing. (As for connection, refer to page 83) Use a sufficiently charged battery or the AC adapter.

The following conditions are necessary for USB connection.

- PC with Windows 2000, Windows XP, or Windows Vista; Macintosh with Intel CPU (Intel Mac)
- USB 2.0 (High Speed, Mass Storage Class) compatibility (not compatible with USB 1.1)
- Only connect to one computer at a time.
- Camera cannot be operated if a hub or other device is connected between the camera and computer.

1 Insert the SD Memory Card, and move the POWER switch to ON.

2 Connect the camera to the computer with the USB connection cable.

Turn the computer's power on before connecting.



3 Touch PC.

4 Perform non-linear editing on the computer.

The contents of the SD Memory Card will appear as a removable disk icon within My Computer or the desktop on the computer screen. (Page 119)

(Example) Windows



Removable disk (E:)

(Example) Macintosh



NO NAME

- When copying files from the camera to a computer, be careful to ensure that files are not accidentally overwritten.
- For more details, please refer to your computer editing software's operating instructions.
- When changing cards, always ensure that the access lamp is not flashing and that the card is not currently being accessed.
- You cannot operate the camera when it is connected to a computer.
- Always perform "safe hardware removal" when disconnecting the cable.
- The data on the SD Memory Card cannot be accessed when the SD Memory Card slot cover is open.

5 Turn the camera's power off.

- If the camera cannot be correctly recognized by the computer, this may be able to be remedied by one of the following methods.
 - Turn the power of the camera and the computer off and back on again.
 - Remove the SD Memory Card from the camera and reinsert it.
 - Connect to a different USB terminal on the computer.

Screen displays

Regular displays

For details on **42** information display, **43** mode check information display, and **44** safety zone, see page 90.

CAMERA mode/PHOTO mode

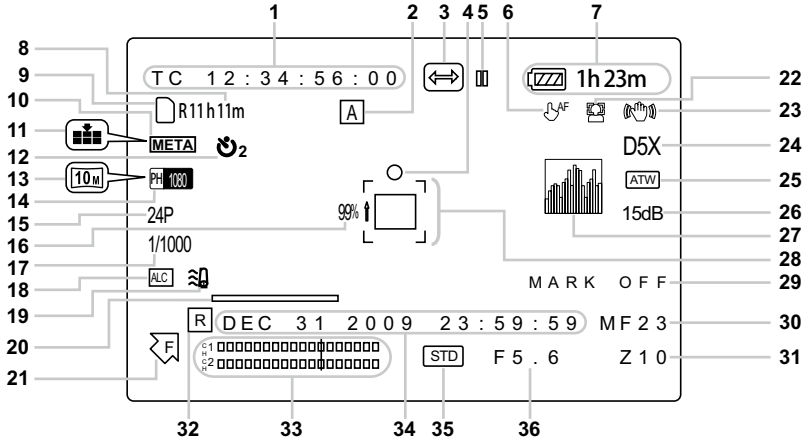

PB mode

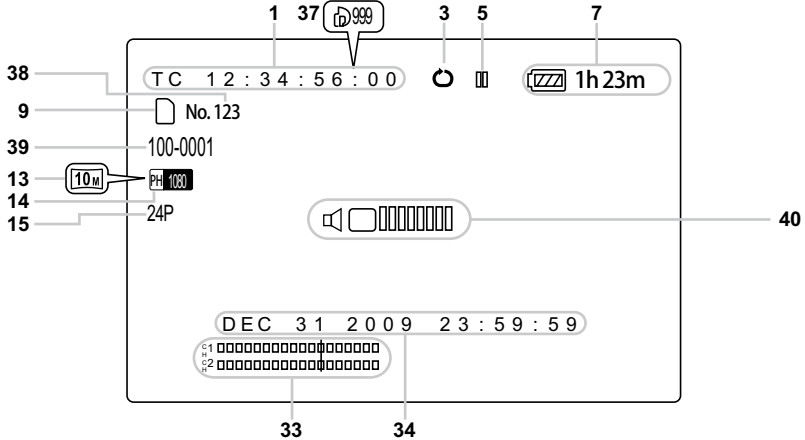

During self-portrait recording

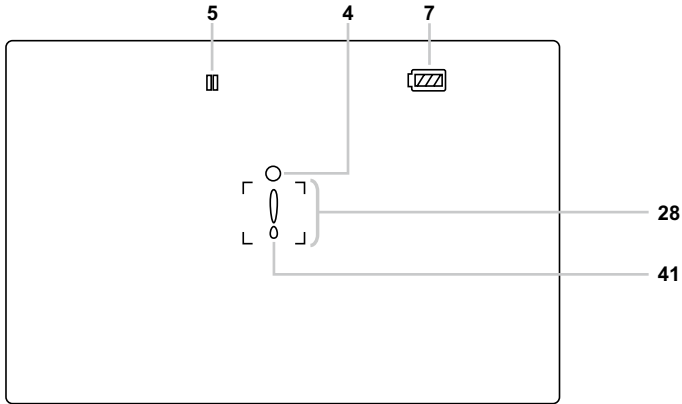

1 Time code display*1

Each time you press the COUNTER button, the display switches over to the following data (or no indication).

COUNTER:

Counter value

CLIP:

Counter value for each recorded clip

Displayed when the REC COUNTER item in the setting menu SW&DISP SETUP screen is set to CLIP.

During playback, the time code display automatically changes to CLIP and counts each clip from 0:00:00.

TC:

Time code value.

When the time code value could not be read correctly from the SD Memory Card, [TC*] is displayed.

UB:

User information

When user information could not be read correctly from the SD Memory Card, [UB*] is displayed.

2 AUTO/MANUAL switch operation display

This display appears when AUTO/MANUAL switch is switched to AUTO.

: Auto shooting

: Auto face detection shooting

3 Recording function display

: Displayed when PREREC MODE is set to ON. (Page 46)

: Displayed when INTERVAL REC is enabled. (Page 48)

: Displayed when REPEAT PLAY is set to ON. (Page 73)

4 Shutter chance display (Page 61)

5 Operation status display

●: Recording

■: (Green) Recording standby

▷: Playback or REC CHECK in progress

□: (White) Playback paused

◀▶ (<▶): Frame-by-frame playback (Frame-by-frame reverse playback)

▶▶ (<<): Fast forward/fast playback (Rewind/fast reverse playback)

Self-portrait recording display

No display: Cannot record (no card, etc.)

●: Recording in progress, transitioning to recording standby mode

■: (Green) Recording standby mode

⚠: Warning display

6 Touch auto focus display

Displayed when touch auto focus is set to ON in the Function Navi.

*1 Will not be output to external devices.



7 Remaining battery capacity display

When using Panasonic-manufactured batteries compatible with this product, the remaining battery capacity is displayed (“m” indicates minutes).

Time remaining will be displayed after a brief pause.

- The battery display will change



as battery capacity decreases.  will be displayed in red when less than 3 minutes are remaining, and  will flash when the battery is empty.

- Remaining battery capacity may not be displayed correctly when using in high or low temperatures, or when the battery has not been used for a long period of time. To ensure that remaining battery capacity is displayed correctly, use the battery completely from a fully-charged state, and charge the battery again. (Remaining battery capacity may still not be displayed correctly if the battery has been used for long periods in high or low temperatures, or if the battery has been recharged a large number of times.)
- The remaining battery capacity display is a guideline and may change according to usage conditions.
- The remaining battery capacity display will momentarily disappear when switching between modes, when conducting REC CHECK operations or when changing the LCD brightness since the capacity is recalculated at these times.
- Not displayed when using AC adapter.

8 Media capacity display

CAMERA mode:

Displays the remaining recording time for the frame rate set with the REC FORMAT item in the setting menu RECORD SETUP screen.

PHOTO mode:

Displays the number of photos that can be recorded under the current quality setting for the QUALITY item in the setting menu PICTURE screen.

9 Media information display

Displays basic information about inserted SD Memory Card.

: (White) Playback possible
(Green) Recognizing card

: No card inserted

10 Metadata mark

Displayed when the META DATA REC item in the setting menu RECORD SETUP screen is set to ON. (Page 57)

11 Quality display

Displays the image quality during PHOTO mode.

12 Self-timer display

Displayed when the SELF TIMER item in the setting menu PICTURE screen is set.

13 Recording pixel display

Displays the recording pixels during PHOTO mode.

14 Recording format display (Page 102)

15 Frame rate display

Displays recording frame rate.

Not displayed when set to 1080/60i.

16 Marker luminance display*2

When markers are displayed, the brightness level around the center of the screen is indicated as 0% to 99%. “99%↑” appears if the percentage is over 99.

Marker display:

During shooting, pressing the ZEBRA button once or twice will display the marker.

17 Shutter speed display

The shutter speed is displayed here.

18 Microphone level automatic control display

Appears when in the setup menus, RECORD SETUP screen, MIC ALC, you have selected “ON”.

19 Wind noise reduction display

Displayed when the WIND CUT item in the setting menu RECORD SETUP screen is set to ON.

20 Focus bar display*1

Displayed when the FOCUS ASSIST SW item in the setting menu SW&DISP SETUP screen is set to BAR.

21 Function key display (Page 97)

*1 Will not be output to external devices.

*2 Will not be displayed when the face detection function is set to ON in the auto mode, unless FACE FRAMING is set to OFF.

22 Face detection frame display

Displayed when the FACE FRAMING item in the setting menu SW&DISP SETUP screen is set to PRIMARY or ALL, and FACE DETECT ON is enabled.

23 Optical Image Stabilizer (OIS) display

Displayed when Optical Image Stabilizer is ON.

24 Digital zoom ratio display

Displays digital zoom ratio.

- D 2X: 2 x zoom
- D 5X: 5 x zoom
- D 10X: 10 x zoom

25 AWB information display

Displays the information of white balance.

- ATW: When ATW is set
- LOCK: When ATW is locked
- P3.2K/P5.6K: In the case of preset
- Ach/Bch: In the case of A/B

26 Gain display

Displays the gain value of the image amplifier configured. (During the auto mode, AGC is displayed.)

Displayed when the LENS STATUS item in the setting menu SW&DISP SETUP screen is set to ON.

27 Histogram display

Displayed in PHOTO mode when the HISTOGRAM item in the setting menu SW&DISP SETUP screen is set to ON.

28 Focus frame display (Page 61)

29 Shot mark recording display

(SHOT MARK)

Displayed when you press a USER button to which the SHOT MARK function has been assigned.

INVALID will be displayed if an index or shot mark cannot be attached.

30 Focus control information display*1

Displays the focus control information with 99 - 00. In the auto focus mode, AF appears. In the manual focus mode, MF appears. When the focus control is set to a macro range, the black and white of AF or MF are displayed in reverse.

95 (Focal distance: infinity)

:

00 (Focal distance: approx. 5 cm)

Depending on the zoom position, the macro range may not be enabled.

Also, depending on the zoom position, the lower limit value of macro range may be different. Displayed when the LENS STATUS item in the setting menu SW&DISP SETUP screen is set to ON.

- When using a macro range for the focus control, zooming may cause the image to become unfocused.

31 Zoom position display*1

The zoom position is displayed with Z00 (maximum wide-angle) - Z99 (maximum zoom).

Displayed when the LENS STATUS item in the setting menu SW&DISP SETUP screen is set to ON.

32 Timestamp display (Page 49)

33 Audio level meter display*1

34 Date and time display

Month:

- JAN (January), FEB (February), MAR (March), APR (April), MAY (May), JUN (June), JUL (July), AUG (August), SEP (September), OCT (October), NOV (November), DEC (December)

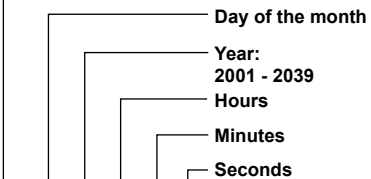

mmm dd yyyy hh:mm:ss

- When the timestamp function is ON, the month display is switched from numbers to words.

*1 Will not be output to external devices.

Screen displays (continued)

35 Auto iris control display

STD: Standard auto-iris control

: Auto iris control for spotlight

: Auto iris control for backlight compensation

36 Iris display

Displays F value.

37 DPOF display (Page 79)

38 Clip number display (Page 65)

39 Photo folder/filename display (Page 66)

40 Monitor audio level meter

Displayed during headphone volume adjustment and speaker volume adjustment.

41 Warning display

Displayed when a warning message appears during self-portrait recording.

42 Information display

Following information is displayed depending on the situation.

- Performance of the auto white balance or the auto black balance
- Warning
- The AWB error message (AWB NG) is displayed.

43 Mode check information display

Displayed when the DISP/MODE CHK button is held down.

44 Safety zone*2

The range of the zone is indicated by the SAFETY ZONE item (Page 107) on the SW&DISP SETUP screen.

4:3 This indicates the position which is cropped to 4:3.



90% This indicates the range (90%) in which signals can be displayed by an ordinary homeuse TV set.



Will not be displayed in the LCD monitor or viewfinder for touch focus operations when the FOCUS ASSIST SW item on the setting menu SW&DISP SETUP screen is set to EXPANDED, or when the face detection function is enabled and the face detection frames are displayed.

*2 Will not be displayed when the face detection function is set to ON in the auto mode, unless FACE FRAMING is set to OFF.

Main warning displays

The main warning displays appearing on the LCD monitor or viewfinder are listed below. If a warning display is not listed, check carefully the message displayed.

■ A

ALL DATA WILL BE DELETED. FORMAT THE CARD NOW?

Do you wish to format the SD Memory Card now? Yes/No

■ C

CANNOT BE USED DUE TO INCOMPATIBLE DATA.

No use is possible because the standard for the data is different.

CANNOT DELETE WITH THIS BUTTON

Clip cannot be deleted.

CANNOT DELETE.

Clip cannot be deleted.

CANNOT PLAY WITH THIS BUTTON

No playback is possible.

CANNOT PLAY.

No playback is possible.

CANNOT RECORD PH MODE AND HA MODE INTO THIS CARD.

This card cannot be recorded to in PH mode or HA mode.

CANNOT SET PRE-REC, CARD CAPACITY TOO LOW.

PRE-REC cannot be set as the remaining card capacity is low.

CANNOT SET THE NUMBER OF INDEXES HAS EXCEEDED THE MAXIMUM LIMIT.

No further indexes can be set because the number of indexes will exceed the maximum limit.

CARD DOOR OPENED.

Close the card door.

CARD ERROR. PLEASE REFORMAT.

Formatting has failed. The card needs to be reformatted.

CARD FULL.

The card is full.

CARD LOCKED.

Unlock the card.

CHECK CARD.

Please check the card.

CONTROL DATA ERROR HAS BEEN DETECTED.

An error has been detected in the control information.

■ D

DISCONNECT USB CABLE.

The camera cannot be operated while connected via USB cable.

DISCONNECT USB CABLE.

When switching from one mode to another, disconnect the USB connection cable.

■ I

INCOMPATIBLE CARD. PLEASE CHECK CARD.

Recording may not be successful with this card. Please check the card.

■ N

NO CARD

No card is inserted.

NOW ACCESSING. PLEASE DO NOT REMOVE CARD.

Card is currently being accessed. Please do not remove the card.

■ R

REC STOPPED. NOW WRITING.

Video recording has been stopped. Data is now being written to the card.

REPAIR CLIP?

Do you wish to repair clips now?

■ S

SET DATE AND TIME

Set the date and time.

■ T

THE CLIP ARE PROTECTED. PLEASE REMOVE THE PROTECTION.

The clip is protected. Please cancel the protection.

THE RECORDING IS STOPPED (OVER THE LIMITATION)

Recording will stop. (Continuous recording for 12 hours)

THE TC MODE IS CHANGED TO "NDF"

NDF is selected as the TC MODE setting.

THIS BATTERY CANNOT BE USED.

This battery cannot be used.

THIS CARD CANNOT RECORD IN VIDEO MODE.

The card cannot be used for video recording.

THUMBNAIL DATA ERROR IS DETECTED.

An error has been detected in the thumbnail information.

■ U

UNABLE TO FORMAT.

The card cannot be formatted.

Error displays

The following messages are displayed when an error has occurred in the camera or the SD Memory Card. If the problem is not solved by switching the power off and back on again, either change the card in accordance with the instructions displayed, or consult the place of purchase.

■ E

ERROR OCCURRED. RECORDING IS STOPPED.

Displayed when an error has occurred during recording. Start the recording again. If the message appears again, please consult the place of purchase.

- Please switch the power off if the message continues to appear.
- Please try inserting a different card if the message appears again after restarting recording.

■ P

POWER TURNED OFF DUE TO FAN STOPPING.

Displayed when an error has occurred with the fan. The power then turns off. Wait a few minutes, and then try turning the power on again.

■ S

SYSTEM ERROR TURN POWER OFF

Displayed when an error has occurred in the system. Switch the power off and back on again.

- If this error is displayed when accessing the SD Memory Card, such as when deleting a clip, the SD Memory Card may be damaged. Please replace it with a new SD Memory Card.
- If this error is displayed when repairing the SD Memory Card, please use the AVCCAM Restorer content repair software (Page 37).

Setting the DISPLAY items

Display the following items on the viewfinder and LCD monitor by pressing the DISP/MODE CHK button or by configuring OTHER DISPLAY of the SW&DISP SETUP screen of the setup menus. (Page 98)

✓ : Displayed
 x : Not displayed
 — : Displayed depending on other settings

Displays	CAMERA mode	PHOTO mode	MODE CHK (Hold down DISP/MODE CHK button)	DISPLAY	OTHER DISPLAY settings	
					ON	OFF
1 Time code display	✓	x	✓	—*1	—*1	—*1
2 AUTO/MANUAL switch operation display	✓	✓	✓	✓	✓	x
3 Recording function display	✓	✓	✓	—	✓	✓
4 Shutter chance display	x	✓	—	—	✓	✓
5 Operation status display	✓	✓	✓	—	—	—
6 Touch auto focus display	✓	x	✓	✓	—*2	x
7 Remaining battery capacity display	✓	✓	✓	✓	—*2	—*2
8 Media capacity display	✓	✓	✓	✓	—*2	—*2
9 Media information display	✓	✓	✓	✓	—*2	—*2
10 Metadata mark	✓	x	✓	✓	✓	x
11 Quality display	x	✓	✓	✓	✓	x
12 Self-timer display	x	✓	—*2	—	✓	✓
13 Recording pixel display	x	✓	✓	✓	✓	x
14 Recording format display	✓	x	✓	✓	✓	x
15 Frame rate display	✓	x	✓	✓	✓	x
16 Marker luminance display	✓	✓	x	—*1	—*1	—*1
17 Shutter speed display	✓	✓	✓	✓	—*3	—*3
18 Mic level automatic control display	✓	x	✓	✓	✓	x
19 Wind noise reduction display	✓	x	✓	✓	✓	x
20 Focus bar display	✓	✓	—*1	—*1	—*1	—*1
21 Function key display	✓	✓	—*4	—*4	—*4	—*4
22 Face detection frame display	✓	✓	✓	✓	—*2	—*2
23 Optical Image Stabilizer display	✓	✓	✓	✓	—*3	—*3
24 Digital zoom ratio display	✓	x	✓	✓	✓	x
25 AWB information display	✓	✓	✓	✓	✓	x
26 Gain display	✓	✓	✓	✓	—*3	—*3
27 Histogram display	x	✓	—*2	—*2	—*2	—*2
28 Focus frame display	x	✓	—	—	✓	✓
29 Shot mark recording display	✓	x	—*1	—*1	—*1	—*1
30 Focus control information display	✓	✓	✓	✓	—*3	—*3
31 Zoom position display	✓	✓	✓	✓	—*3	—*3
32 Timestamp display	✓	x	—*2	—*2	—*2	—*2
33 Audio level meter display	✓	x	✓	✓	—*2	—*2

(Continued on the next page)

Screen displays (continued)

34 Date and time display	✓	✓	✓	✓	—*2	—*2
35 Auto iris control display	✓	✓	✓	✓	—*3	—*3
36 Iris display	✓	✓	✓	✓	—*3	—*3
37 DPOF display	x	✓	—	—	✓	✓
38 Clip number display	✓	✓	✓	✓	—*2	—*2
39 Photo folder/filename display	x	✓	✓	✓	—*2	—*2
40 Monitor audio level meter	✓	✓	—*1	—*1	—*1	—*1
41 Warning display	✓	✓	—*5	—*5	—*5	—*5
42 Information display	✓	✓	—*5	—*5	—*5	—*5
43 Mode check information display	✓	✓	✓	—	—	—

*1 Toggle display with the buttons.

*2 Toggle display with menu item settings other than those listed above.

*3 Displayed when the LENS STATUS item in the setting menu SW&DISP SETUP screen is set to ON.

*4 Toggle display by touching the LCD panel.

*5 Displayed during warnings.

The item in ✓ in the MODE CHECK space appears when you press and hold the DISP/MODE CHK button.

The item in ✓ in the DISPLAY space disappears when you press the DISP/MODE CHK button.

Using the setup menus

Use the setup menus to change the settings to suit the scenes you are shooting or what you are recording.

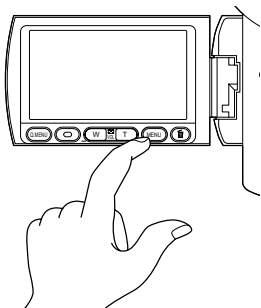

Using the menus

- The menu items indicated in the gray characters cannot be changed its settings.

1 When the unit is in other than playback or recording mode, press the MENU button.

The following is displayed on the viewfinder and LCD monitor.

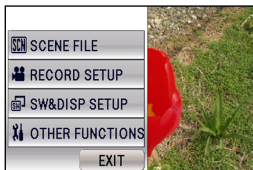

2 Touch the function you want to set.

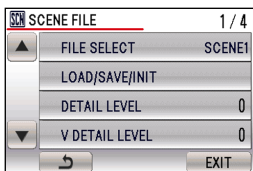

- To switch pages, touch ▲ or ▼.

3 Touch the item you want to set.

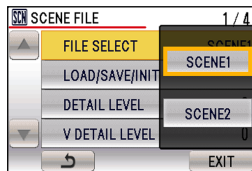

- To return to a previous screen, touch ↶.

4 Touch the setting option.

- To change numerical values, touch ◀ or ▶ to change the values.
- To return to a previous screen, touch ↶.

5 Repeat steps 3 – 4 to set any other items.

To complete settings, touch EXIT or press the MENU button.

6 Repeat steps 2 – 4 to set any other functions.

To complete settings, touch EXIT or press the MENU button.

Using Quick Menu and Function Navi

Certain items can be set quickly using Quick Menu and Function Navi.

■ Quick Menu

1 Press the Q.MENU button.

2 Touch the item.

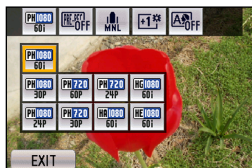

3 Touch the items to set them.

You can set the following items in Quick Menu.

- The items that appear may vary depending on the mode and settings.

Icon	Item	Display mode	Page
	REC FORMAT	CAMERA	Page 102
	PICTURE SIZE	PHOTO	Page 104
	PREREC MODE	CAMERA	Page 102
	GUIDE LINES	PHOTO	Page 107
	MIC LEVEL SEL	CAMERA	Page 103
	HISTOGRAM	PHOTO	Page 107
	LCD BACKLIGHT	CAMERA PHOTO	Page 108
	AUTO SW (FACE DETECT)	CAMERA PHOTO	Page 106

4 Touch EXIT or press the Q.MENU button to close Quick Menu.

■ Function Navi

1 Touch the LCD monitor.

2 Touch .



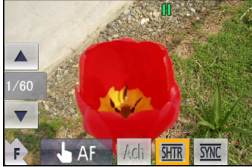





3 Touch the item.



- To change numerical values, touch ▲ or ▼ to select the values.

You can set the following items in Function Navi.

- The items that appear may vary depending on the mode and settings.

Icon	Item	Display mode	Page
	Touch auto focus	CAMERA	Page 44
	WHITE BALANCE	CAMERA PHOTO	Page 42
	SHUTTER SPEED	CAMERA PHOTO	Page 50
	SYNCRO SCAN	CAMERA	Page 52
	MIC LEVEL	CAMERA	Page 53
	Headphone volume	CAMERA	Page 47
	SELF TIMER	PHOTO	Page 104
	I.EXPOSURE	PHOTO	Page 101
	SKIN TONE DTL	PHOTO	Page 101

4 Touch the item when it have been set.

5 Touch .

Initializing the menu settings

You can return the setting values for each item to their factory default settings with the MENU INIT item in the setting menu OTHER FUNCTION screen.

To initialize menu settings, set this item to YES.

Setting values for the following items are not initialized.

- Time code values
- CLOCK SET
- OPERATION TIME

Setup menu structure

CAMERA mode menu

Video recording menu

- SCENE FILE (Page 100)
 - FILE SELECT
 - LOAD/SAVE/INIT
 - DETAIL LEVEL
 - V DETAIL LEVEL
 - DETAIL CORING
 - CHROMA LEVEL
 - CHROMA PHASE
 - COLOR TEMP
 - MASTER PED
 - A.IRIS LEVEL
 - DRS
 - GAMMA
 - KNEE
 - MATRIX
 - SKIN TONE DTL
- RECORD SETUP (Page 102)
 - REC FORMAT
 - PREREC MODE
 - TIME STAMP
 - INTERVAL REC
 - TC MODE
 - TCG
 - TC PRESET
 - UB PRESET
 - WIND CUT
 - MIC ALC
 - MIC LEVEL SEL
 - META CARD READ
 - META DATA REC
 - USER CLIP NAME
 - META DATA PROP
 - CLIP COUNTER RST
 - META INITIAL SET
- SW&DISP SETUP (Page 106)
 - IRIS DIAL
 - USER1 SW
 - USER2 SW
 - USER3 SW
 - FOCUS ASSIST SW
 - RING SW
 - AUTO SW
 - SMOOTH ZOOM STOP
 - CAM GAIN LIMIT
 - FACE FRAMING
 - ZEBRA DETECT
 - MARKER
 - SAFETY ZONE
 - REC COUNTER
 - VIDEO OUT OSD
 - DATE/TIME
 - DATE FORMAT
 - LEVEL METER
 - LENS STATUS
 - CARD & BATTERY
 - OTHER DISPLAY
 - LCD BACKLIGHT
 - LCD SET
 - EVF SET
 - SELF SHOOT
 - EVF MODE
 - EVF COLOR
- OTHER FUNCTIONS (Page 109)
 - CARD FORMAT
 - IR REMOTE
 - REC LAMP
 - BEEP SOUND
 - CLOCK SET
 - TIME ZONE
 - POWER SAVE
 - QUICK POWER ON
 - HDMI OUT SEL
 - CMPNT OUT SEL
 - DOWNCON MODE
 - VIDEO SETUP
 - AUDIO OUT
 - MENU INIT
 - SYSTEM INFO
 - CALIBRATION
 - LANGUAGE
 - OPERATION TIME

PHOTO mode menu

Photo recording menu

- CAMERA SETUP (Page 101)
 - I.EXPOSURE
 - DETAIL LEVEL
 - CHROMA LEVEL
 - A.IRIS LEVEL
 - SKIN TONE DTL
- PICTURE (Page 104)
 - PICTURE SIZE
 - QUALITY
 - ASPECT RATIO
 - SELF TIMER
 - SHTR SOUND
- SW&DISP SETUP (Page 106)
 - IRIS DIAL
 - USER1 SW
 - USER2 SW
 - USER3 SW
 - FOCUS ASSIST SW
 - RING SW
 - AUTO SW
 - SMOOTH ZOOM STOP
 - CAM GAIN LIMIT
 - FACE FRAMING
 - ZEBRA DETECT
 - MARKER
 - GUIDE LINES
 - HISTOGRAM
 - VIDEO OUT OSD
 - DATE/TIME
 - DATE FORMAT
 - LENS STATUS
 - CARD & BATTERY
 - OTHER DISPLAY
 - LCD BACKLIGHT
 - LCD SET
 - EVF SET
 - SELF SHOOT
 - EVF MODE
 - EVF COLOR
- OTHER FUNCTIONS (Page 109)
 - CARD FORMAT
 - IR REMOTE
 - REC LAMP
 - BEEP SOUND
 - CLOCK SET
 - TIME ZONE
 - POWER SAVE
 - QUICK POWER ON
 - HDMI OUT SEL
 - CMPNT OUT SEL
 - TV ASPECT
 - MENU INIT
 - SYSTEM INFO
 - CALIBRATION
 - LANGUAGE
 - OPERATION TIME

PB mode menu

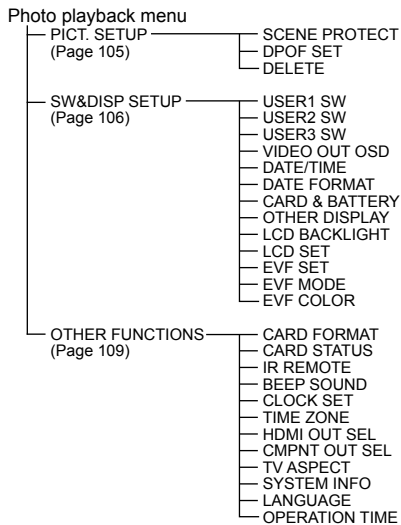
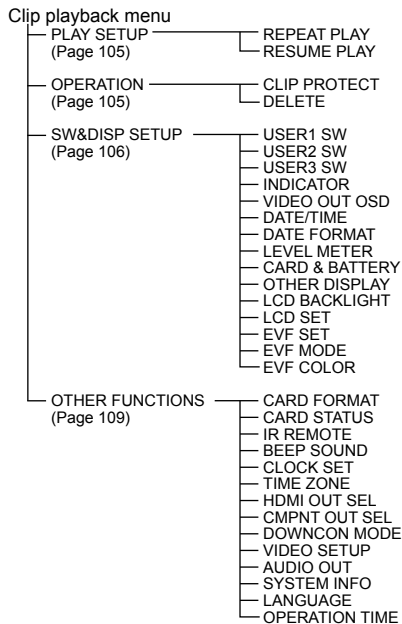

Setup menu list

SCENE FILE screen

Item	Display mode	Description of settings
FILE SELECT	CAMERA	Selects the scene file. SCENE1 SCENE2
LOAD/SAVE/INIT	CAMERA	Loads, saves, or initializes the scene file selected with FILE SELECT. LOAD: Loads the scene file settings set on this camera. SAVE: Saves changed scene file settings. INIT: Returns current setting values to factory default settings. NO: Returns to the last screen.
DETAIL LEVEL	CAMERA	Adjusts the level of the image outline correction (in the horizontal and vertical directions). - 7... <u>0</u> ...+ 7
V DETAIL LEVEL	CAMERA	Adjusts the level of outline correction in the vertical direction. - 7... <u>0</u> ...+ 7
DETAIL CORING	CAMERA	Adjusts the level of noise reduction of the detail signal. - 7... <u>0</u> ...+ 7 Set to - for a clearer image. Noise increases slightly. Set to + to reduce noise.
CHROMA LEVEL	CAMERA	Adjusts the chroma level. - 7... <u>0</u> ...+ 7
CHROMA PHASE	CAMERA	Makes fine adjustments to the chroma phase. - 7... <u>0</u> ...+ 7
COLOR TEMP	CAMERA	Makes fine adjustments to the color temperature. - 7... <u>0</u> ...+ 7 • Enabled when presets, Ach, or Bch are configured for white balance in manual mode.
MASTER PED	CAMERA	Adjusts the master pedestal (black level of the image) as the basis for images. - 15... <u>0</u> ...+ 15
A.IRIS LEVEL	CAMERA	Sets the desired AUTO IRIS level. - 10... <u>0</u> ...+ 10
DRS	CAMERA	Selects the DRS (dynamic range stretcher) function. It enables the dynamic range to be expanded by compressing the level of the video signals in the high-brightness areas where overexposure results during normal shooting. OFF, 1, 2, 3 • The higher the number of the setting, the higher the compression level of the high-brightness areas.
GAMMA	CAMERA	Selects the gamma curves. HD NORM: This gamma setting is suitable for HD shooting. LOW: Makes a mellow image using the gamma curve which has a gentle incline in low-brightness curve. The contrast sharpens. SD NORM: This is the normal video setting, carried over from the DVX100 series. HIGH: Expands the tone of dark parts and makes a brighter image using the gamma curve which has a sharp incline in low-brightness curve. The contrast softens. B.PRESS: Makes the contrast shaper than LOW. CINE-LIKE D: Uses a gamma designed to create cinema-like images. CINE-LIKE V: Uses a gamma designed to create cinema-like images with emphasized contrast. • When you select CINE-LIKE gamma, we recommend setting the lens aperture lower than normal image level (approximately 1/2) for optimal results.

___ indicates the factory setting.

SCENE FILE screen (continued)

Item	Display mode	Description of settings
KNEE	CAMERA	To avoid overexposure, select the compression level (knee point) of the high intensity video signals received through the pickup device. AUTO: Sets the level automatically according to the received signals. LOW: Low setting (Compression starts at approx. 80%.) MID: Medium setting (Compression starts at approx. 90%.) HIGH: High Setting (Compression starts at approx. 100%.) • Not available when a DRS value is set, or when GAMMA is set to CINE-LIKE.
MATRIX	CAMERA	Selects the MATRIX table suitable for the desired color expression during shooting. NORM1: Suitable for shooting in the open air or under a halogen lamp. NORM2: Suitable for brighter colors than the NORM1 mode. FLUO: Suitable for shooting under fluorescent light indoors. CINE-LIKE: Suitable for cinema-like image.
SKIN TONE DTL	CAMERA	Switches skin tone details on or off. Select ON to reduce the skin tone details and soften the skin tone. ON OFF

CAMERA SETUP screen

Item	Display mode	Description of settings
I.EXPOSURE	PHOTO	Enables brightness compensation for shooting dark, hard-to-see areas. ON OFF • Can only be selected in manual mode.
DETAIL LEVEL	PHOTO	Adjusts the level of the image outline correction (in the horizontal and vertical directions). - 7...0...+ 7
CHROMA LEVEL	PHOTO	Adjusts the chroma level. - 7...0...+ 7
A.IRIS LEVEL	PHOTO	Sets the desired AUTO IRIS level. - 10...0...+ 10
SKIN TONE DTL	PHOTO	Switches skin tone details on or off. Select ON to reduce the skin tone details and soften the skin tone. ON OFF

___ indicates the factory setting.

Setup menu list (continued)

RECORD SETUP screen

Item	Display mode	Q.MENU	Description of settings
REC FORMAT	CAMERA	✓	Selects the recording format. PH 1080/60i PH 1080/30P PH 1080/24P PH 720/60P PH 720/30P PH 720/24P HA 1080/60i HG 1080/60i HE 1080/60i <ul style="list-style-type: none"> • PH 1080/24P and PH 720/24P represent native recording. • You cannot change the format during interval recording.
PREREC MODE	CAMERA	✓	Sets PRE RECORDING to ON or OFF. (Page 46) ON OFF <ul style="list-style-type: none"> • TCG is set to FREE RUN. • Cannot be set during INTERVAL REC.
TIME STAMP	CAMERA		Specifies whether date and time information is superimposed over recorded images. ON: Superimposes date and time information on the image. OFF: Does not superimpose date and time information on the image.
INTERVAL REC	CAMERA		Enables frame-by-frame recording at specified intervals to create short videos of scenes with slow movement over long periods of time. Single frames are recorded at the specified interval, with 24 frames equaling 1 second of video. OFF, 1 SECOND, 10 SECONDS, 30 SECONDS, 1 MINUTE, 2 MINUTES <ul style="list-style-type: none"> • When INTERVAL REC is enabled, the following setting items automatically change as follows. REC FORMAT: PH 1080/24P, TC MODE: NDF
TC MODE	CAMERA		Selects the correction mode of the internal time code generator when the time code of the internal time code generator is recorded. DF: Uses the drop frame mode. NDF: Uses the non-drop frame mode. <ul style="list-style-type: none"> • TC MODE is automatically set to NDF when you set recording frame rate of recording format to 24P.
TCG	CAMERA		Sets the mode in which you advance the internal time code generator. FREE RUN: The time code is advanced regardless of the operation mode. A slight time error may occur when switching to PB mode if the frame rate is set to 24P. REC RUN: The time code is advanced only when recording.
TC PRESET	CAMERA		Sets the initial time code. YES NO <ul style="list-style-type: none"> • Set the frame value to 0 or a multiple of 4 when you set recording frame rate of recording format to 24P. If any other value is set, the recorded time code will mis-match.
UB PRESET	CAMERA		Sets the user information. YES NO

✓: Can also be configured in Quick Menu. (Page 96)

___ indicates the factory setting.

RECORD SETUP screen (continued)















Item	Display mode	Q.MENU	Description of settings
WIND CUT	CAMERA		Reduces noise caused by strong wind blowing against the built-in mic. ON OFF • When an external mic or an XLR Microphone Adapter is connected, this setting is fixed at OFF.
MIC ALC	CAMERA		Sets mic level auto control to ON or OFF (CH1 and CH2 simultaneously). ON OFF • Set to ON to reduce distortion at high input levels. To adjust the recording level of audio signals (not related to this setting), adjust the mic settings in the Function Navi.
MIC LEVEL SEL	CAMERA	✓	Selects whether to fix built-in mic and external mic input to a standard level. FIX: Fixes the input level. MANUAL: Enables manual input level adjustment. • Adjust input levels with the mic input level setting in the Function Navi. • When an XLR Microphone Adapter is connected, the camera's mic input level is fixed. Adjust the volume on the microphone adapter to adjust the input level.
META CARD READ	CAMERA		Loads the metadata recorded on the SD Memory Card into the unit. Up to 8 metadata files stored on the SD Memory Card (MTDT00 to MTDT07) are displayed in a list. Files with no corresponding data are displayed in gray. • Displayed in gray when metadata is not stored on the SD Memory Card.
META DATA REC	CAMERA		Sets whether to record the metadata to be loaded into the unit simultaneously on a SD Memory Card. ON: Records simultaneously. OFF: Does not record simultaneously.
USER CLIP NAME	CAMERA		Selects the method of CLIP NAME recording. TYPE1: User clip name is the same as the CLIP NAME if there is no uploaded metadata or data. TYPE2: User clip name is the same as the CLIP NAME if no combination of data and COUNT value is uploaded, or if there is no uploaded data.
META DATA PROP	CAMERA		Displays the metadata which has been recorded in the unit. CLIP NAME ACCESS SHOOT SCENARIO NEWS1 NEWS2 MEMO1 MEMO2
CLIP COUNTER RST	CAMERA		Resets the COUNT value to 1. YES NO
META INITIAL SET	CAMERA		Returns metadata stored on the camera to factory default conditions. All metadata settings, including ON/OFF settings for META DATA REC, are cleared. YES NO

✓: Can also be configured in Quick Menu. (Page 96)

_____ indicates the factory setting.

Setup menu list (continued)

PICTURE screen

Item	Display mode	Q.MENU	Description of settings
PICTURE SIZE	PHOTO	✓	Sets the recording pixels during photo shooting. 4:3 image aspect ratio:  : 3520×2640  : 3264×2448  : 2560×1920  : 640×480 3:2 image aspect ratio:  : 3984×2656  : 3264×2176  : 2592×1728 16:9 image aspect ratio:  : 4224×2376  : 3328×1872  : 2560×1440
QUALITY	PHOTO		Sets the image quality during photo shooting.  : High image quality  : Standard image quality
ASPECT RATIO	PHOTO		Sets the aspect ratio.  4:3  3:2  16:9
SELF TIMER	PHOTO		Sets the self timer. OFF, 10 SECONDS, 2 SECONDS
SHTR SOUND	PHOTO		Selects whether to enable the shutter sound. ON OFF

✓: Can also be configured in Quick Menu. (Page 96)

___ indicates the factory setting.

PLAY SETUP screen

Item	Display mode	Description of settings
REPEAT PLAY	PB	When set to ON, supported clips are played repeatedly. ON OFF
RESUME PLAY	PB	When set to ON, playback resumes from the video position at which clip playback stopped. ON OFF

OPERATION screen

Item	Display mode	Description of settings
CLIP PROTECT	PB	Protects clips to prevent accidental deletion. YES: Enables clip protection or cancels protection. NO • Executing a format of the memory card will delete all clips even if they are protected.
DELETE	PB	Deletes clips. ALL CLIPS: Deletes all clips. SELECT: Deletes only the selected clips. Press the  button to perform deletion. NO • Clips for which CLIP PROTECT is specified are not deleted.



PICT. SETUP screen

Item	Display mode	Description of settings
SCENE PROTECT	PB	Protects photos to prevent accidental deletion. YES: Enables photo protection or cancels protection. NO • Executing a format of the memory will delete photos even if they are protected.
DPOF SET	PB	Allows you to write data related to the print quantity of a photo onto the SD Memory Card. CANCEL ALL: Cancels all quantity settings. SET: Sets the print quantity. NO
DELETE	PB	Deletes photos. ALL SCENES: Deletes all photos. SELECT: Deletes only the selected photos. Press the  button to perform deletion. NO • Photos for which SCENE PROTECT is specified are not deleted.

___ indicates the factory setting.

Setup menu list (continued)

SW&DISP SETUP screen

Item	Display mode	Q.MENU	Description of settings
IRIS DIAL	CAMERA PHOTO		Sets the rotation direction and the aperture control of the IRIS dial. (In MANUAL IRIS mode) DOWN OPEN: The iris opens when the IRIS dial is turned downward. UP OPEN: The iris opens when the IRIS dial is turned upward.
USER1 SW	CAMERA PHOTO PB		Selects the function assigned to the USER1 button. INH: No function assigned. (PUSH)AF: Switches to auto focus mode when the button is held during manual focus mode. BACKLIGHT: Auto iris control for the backlight compensation. (Page 47) SPOTLIGHT: Switches auto iris control for the spotlight on or off. BLACKFADE: Blackfade (Page 46) WHITEFADE: Whitefade (Page 46) ATW: Switches the ATW function on or off. ATW LOCK: Fixes the white balance value when the button is pressed during ATW. Press again to perform ATW. HIGH GAIN: The gain mode switches between normal and high with each press of the button. Gain can be set to up to 34 dB in high gain mode. (Page 41) D.ZOOM: Changes the ratio of the DIGITAL ZOOM function. Each press of the button changes the ratio in the following order: OFF (x1) → x2 → x5 → x10 → OFF (x1). (Page 38) EVF DTL: Emphasizes outlines of images in the LCD monitor and viewfinder for easier focusing when the button is pressed. SHOT MARK: Shot mark recording (Page 47) LAST CLIP: Deletes the last recorded clip. (Page 49) WFM: Displays a waveform on the LCD monitor (only during CAMERA mode).
USER2 SW	CAMERA PHOTO PB		Assigns a function to the USER2 button. The setting contents are the same as USER1 SW. BACKLIGHT
USER3 SW	CAMERA PHOTO PB		Assigns a function to the USER3 button. The setting contents are the same as USER1 SW. SHOT MARK
INDICATOR	PB		Selects whether to display the thumbnail indicator. ON: Displayed OFF: Not displayed
FOCUS ASSIST SW	CAMERA PHOTO		Assigns a function to the FOCUS ASSIST button. EXPANDED: Displays the center of the screen in expanded view. BAR: A bar extends to the right as focus is aligned. BOTH: Enables both expanded view and focus bar display.
RING SW	CAMERA PHOTO		Assigns a function to the RING switch. ZOOM: Switch between FOCUS and ZOOM. IRIS: Switch between FOCUS and IRIS.
AUTO SW	CAMERA PHOTO	✓	Sets the face detection function during auto mode to ON or OFF.  ON: Enables face detection.  OFF: Disables face detection.

✓: Can also be configured in Quick Menu. (Page 96)

_____ indicates the factory setting.

SW&DISP SETUP screen (continued)

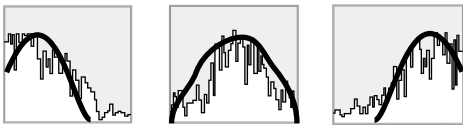
Item	Display mode	Q.MENU	Description of settings
SMOOTH ZOOM STOP	CAMERA PHOTO		Selects the method in which zoom operations are stopped. ON: Smooth stop. OFF: Precise stop.
CAM GAIN LIMIT	CAMERA PHOTO		Sets the maximum value for camera gain. CAMERA mode 24 dB: Camera gain can be set to up to 24 dB. 12 dB: Camera gain can be set to up to 12 dB. PHOTO mode 18 dB: Camera gain can be set to up to 18 dB. 12 dB: Camera gain can be set to up to 12 dB.
FACE FRAMING	CAMERA PHOTO		Sets the detection frame displays when ON is selected in auto mode. OFF: Not displayed. PRIMARY: Displays only the primary frame. ALL: Displays all face detection frames.
ZEBRA DETECT	CAMERA PHOTO		Selects the brightness level of the left-leaning zebra patterns on the screen. 105%, 100%, 95%, 90%, 85%, 80%, 75%, 70%, 65%, 60%, 55%, 50%
MARKER	CAMERA PHOTO		Select ON to display the marker. ON OFF To display the marker, press the ZEBRA button.
GUIDE LINES	PHOTO	✓	Displays guide lines for confirming level shooting. OFF,  • Guide lines are not recorded on images. • Guide lines do not appear when the face detection function is set to ON.
HISTOGRAM	PHOTO	✓	Displays a graph with the horizontal axis representing brightness, and the vertical axis representing number of pixels. You can determine the exposure distribution of an entire image by viewing the distribution in the graph. ON OFF ■ Display example  Dark ← Standard → Light • Adjust the brightness by adjusting the aperture.
SAFETY ZONE	CAMERA		Sets SAFETY ZONE. OFF, 90%, 4:3
REC COUNTER	CAMERA		Selects counter operation during recording. TOTAL: The count continues to increase until the RESET button is pressed to reset it. CLIP: Resets the counter at start of recording and counts the time of each recording session. • In PB mode, operation is always in CLIP mode.

✓: Can also be configured in Quick Menu. (Page 96)

_____ indicates the factory setting.

Setup menu list (continued)

SW&DISP SETUP screen (continued)

Item	Display mode	Q.MENU	Description of settings
VIDEO OUT OSD	CAMERA PHOTO PB		Select ON to output the information displayed on the screen together with the signals from the VIDEO OUT jack. ON OFF • Even when set to ON, the time code display, audio level meter display, focus information display, and zoom position display are not displayed.
DATE/TIME	CAMERA PHOTO PB		Sets whether to display the date and time on the screen and whether to output from the VIDEO OUT jack. OFF: The date and time are not displayed. TIME: The time is displayed. DATE: The date is displayed. TIME & DATE: The date and time are displayed.
DATE FORMAT	CAMERA PHOTO PB		Selects the display format for dates. Y/M/D: Year/month/day M/D/Y: Month/day/year D/M/Y: Day/month/year
LEVEL METER	CAMERA PHOTO PB		Select ON to display the audio level meter. ON OFF
LENS STATUS	CAMERA PHOTO		Sets lens-related displays to ON or OFF (Optical Image Stabilizer, shutter, aperture, zoom, auto iris, and focus displays). ON OFF
CARD & BATTERY	CAMERA PHOTO PB		Select ON to display the remaining SD Memory Card recording capacity and remaining battery charge. ON OFF
OTHER DISPLAY	CAMERA PHOTO PB		Select whether additional information is displayed on the viewfinder and the LCD monitor. (Page 93) ON OFF
LCD BACKLIGHT	CAMERA PHOTO PB	✓	Adjusts the backlight of the LCD monitor. The brightness increases as the setting value increases.
LCD SET	CAMERA PHOTO PB		Adjusts the display level of the images on the LCD monitor. (Page 31) COLOR BRIGHTNESS CONTRAST
EVF SET	CAMERA PHOTO PB		Adjusts the display level of the images on the viewfinder. (Page 31) COLOR BRIGHTNESS CONTRAST
SELF SHOOT	CAMERA PHOTO		Selects the LCD mirror mode for self-portrait shooting. Selecting MIRROR displays the left and right side of the LCD monitor image inverted during selfportrait shooting. (Page 44) NORMAL MIRROR
EVF MODE	CAMERA PHOTO PB		Selects the viewfinder display mode. AUTO: Viewfinder display turns off when the LCD monitor is open. ON: Viewfinder display is always on.
EVF COLOR	CAMERA PHOTO PB		Switches viewfinder images to color or black and white. ON: Color OFF: Black and white

✓: Can also be configured in Quick Menu. (Page 96)

_____ indicates the factory setting.

OTHER FUNCTIONS screen

Item	Display mode	Description of settings																																																																																																												
CARD FORMAT	CAMERA PHOTO PB	Formats the SD Memory Card. YES: Formats the card. NO																																																																																																												
CARD STATUS	PB	Displays the SD Memory Card status. YES: Displays the card status. NO																																																																																																												
IR REMOTE	CAMERA PHOTO PB	Sets the operations of the supplied remote control unit. ON: Accepts commands from the remote control. OFF: Operations are not accepted from remote control.																																																																																																												
REC LAMP	CAMERA PHOTO	Sets lighting of the tally lamp. ON OFF																																																																																																												
BEEP SOUND	CAMERA PHOTO PB	Turns the beep sound ON or OFF. ON OFF If the SD Memory Card becomes FULL while ON is selected, the beep sound is output. The touch panel operation sound and the warning sound are also output. When the beep is sounded, the audio signals from the output connector are muted before the beep sound is output.																																																																																																												
CLOCK SET	CAMERA PHOTO PB	Sets the camera-recorder's calendar. YES NO																																																																																																												
TIME ZONE	CAMERA PHOTO PB	Adds to or deducts from GMT the time value of -12:00 to +13:00 in 30-minute steps. (Refer to the table below.) +00:00																																																																																																												
		<table border="1"> <thead> <tr> <th>Time difference</th> <th>Area</th> <th>Time difference</th> <th>Area</th> </tr> </thead> <tbody> <tr><td>+ 00:00</td><td>Greenwich</td><td>- 00:30</td><td></td></tr> <tr><td>- 01:00</td><td>Azores Islands</td><td>- 01:30</td><td></td></tr> <tr><td>- 02:00</td><td>Mid-Atlantic</td><td>- 02:30</td><td></td></tr> <tr><td>- 03:00</td><td>Buenos Aires</td><td>- 03:30</td><td>Newfoundland Island</td></tr> <tr><td>- 04:00</td><td>Halifax</td><td>- 04:30</td><td></td></tr> <tr><td>- 05:00</td><td>New York</td><td>- 05:30</td><td></td></tr> <tr><td>- 06:00</td><td>Chicago</td><td>- 06:30</td><td></td></tr> <tr><td>- 07:00</td><td>Denver</td><td>- 07:30</td><td></td></tr> <tr><td>- 08:00</td><td>Los Angeles</td><td>- 08:30</td><td></td></tr> <tr><td>- 09:00</td><td>Alaska</td><td>- 09:30</td><td>Marquesas Islands</td></tr> <tr><td>- 10:00</td><td>Hawaii</td><td>- 10:30</td><td></td></tr> <tr><td>- 11:00</td><td>Midway Island</td><td>- 11:30</td><td></td></tr> <tr><td>- 12:00</td><td>Kwajalein</td><td>+ 12:30</td><td></td></tr> <tr><td>+ 13:00</td><td></td><td>+ 11:30</td><td>Norfolk Island</td></tr> <tr><td>+ 12:00</td><td>New Zealand</td><td>+ 10:30</td><td>Lord Howe Island</td></tr> <tr><td>+ 11:00</td><td>Solomon Islands</td><td>+ 09:30</td><td>Darwin</td></tr> <tr><td>+ 10:00</td><td>Guam</td><td>+ 08:30</td><td></td></tr> <tr><td>+ 09:00</td><td>Tokyo</td><td>+ 07:30</td><td></td></tr> <tr><td>+ 08:00</td><td>Beijing</td><td>+ 06:30</td><td>Yangon</td></tr> <tr><td>+ 07:00</td><td>Bangkok</td><td>+ 05:30</td><td>Mumbai</td></tr> <tr><td>+ 06:00</td><td>Dacca</td><td>+ 04:30</td><td>Kabul</td></tr> <tr><td>+ 05:00</td><td>Islamabad</td><td>+ 03:30</td><td>Tehran</td></tr> <tr><td>+ 04:00</td><td>Abu Dhabi</td><td>+ 02:30</td><td></td></tr> <tr><td>+ 03:00</td><td>Moscow</td><td>+ 01:30</td><td></td></tr> <tr><td>+ 02:00</td><td>Eastern Europe</td><td>+ 00:30</td><td></td></tr> <tr><td>+ 01:00</td><td>Central Europe</td><td></td><td></td></tr> </tbody> </table>	Time difference	Area	Time difference	Area	+ 00:00	Greenwich	- 00:30		- 01:00	Azores Islands	- 01:30		- 02:00	Mid-Atlantic	- 02:30		- 03:00	Buenos Aires	- 03:30	Newfoundland Island	- 04:00	Halifax	- 04:30		- 05:00	New York	- 05:30		- 06:00	Chicago	- 06:30		- 07:00	Denver	- 07:30		- 08:00	Los Angeles	- 08:30		- 09:00	Alaska	- 09:30	Marquesas Islands	- 10:00	Hawaii	- 10:30		- 11:00	Midway Island	- 11:30		- 12:00	Kwajalein	+ 12:30		+ 13:00		+ 11:30	Norfolk Island	+ 12:00	New Zealand	+ 10:30	Lord Howe Island	+ 11:00	Solomon Islands	+ 09:30	Darwin	+ 10:00	Guam	+ 08:30		+ 09:00	Tokyo	+ 07:30		+ 08:00	Beijing	+ 06:30	Yangon	+ 07:00	Bangkok	+ 05:30	Mumbai	+ 06:00	Dacca	+ 04:30	Kabul	+ 05:00	Islamabad	+ 03:30	Tehran	+ 04:00	Abu Dhabi	+ 02:30		+ 03:00	Moscow	+ 01:30		+ 02:00	Eastern Europe	+ 00:30		+ 01:00	Central Europe		
Time difference	Area	Time difference	Area																																																																																																											
+ 00:00	Greenwich	- 00:30																																																																																																												
- 01:00	Azores Islands	- 01:30																																																																																																												
- 02:00	Mid-Atlantic	- 02:30																																																																																																												
- 03:00	Buenos Aires	- 03:30	Newfoundland Island																																																																																																											
- 04:00	Halifax	- 04:30																																																																																																												
- 05:00	New York	- 05:30																																																																																																												
- 06:00	Chicago	- 06:30																																																																																																												
- 07:00	Denver	- 07:30																																																																																																												
- 08:00	Los Angeles	- 08:30																																																																																																												
- 09:00	Alaska	- 09:30	Marquesas Islands																																																																																																											
- 10:00	Hawaii	- 10:30																																																																																																												
- 11:00	Midway Island	- 11:30																																																																																																												
- 12:00	Kwajalein	+ 12:30																																																																																																												
+ 13:00		+ 11:30	Norfolk Island																																																																																																											
+ 12:00	New Zealand	+ 10:30	Lord Howe Island																																																																																																											
+ 11:00	Solomon Islands	+ 09:30	Darwin																																																																																																											
+ 10:00	Guam	+ 08:30																																																																																																												
+ 09:00	Tokyo	+ 07:30																																																																																																												
+ 08:00	Beijing	+ 06:30	Yangon																																																																																																											
+ 07:00	Bangkok	+ 05:30	Mumbai																																																																																																											
+ 06:00	Dacca	+ 04:30	Kabul																																																																																																											
+ 05:00	Islamabad	+ 03:30	Tehran																																																																																																											
+ 04:00	Abu Dhabi	+ 02:30																																																																																																												
+ 03:00	Moscow	+ 01:30																																																																																																												
+ 02:00	Eastern Europe	+ 00:30																																																																																																												
+ 01:00	Central Europe																																																																																																													

___ indicates the factory setting.

Setup menu list (continued)

OTHER FUNCTIONS screen (continued)

Item	Display mode	Description of settings
POWER SAVE	CAMERA PHOTO	<p>Selects the power-saving mode when the camera is not operated for about 5 minutes while an SD Memory Card is inserted in CAMERA mode.</p> <p>ON: The camera-recorder's power is set to OFF.</p> <p>OFF: The camera-recorder's power is not set to OFF.</p> <ul style="list-style-type: none"> • Even when this setting is ON, the power will not turn OFF when an SD Memory Card is not inserted, when the camera is in PB mode, or when the AC adapter is connected. • Designated operations include button and ring operations, opening/closing/ touching of the LCD monitor, and remote control operations (when IR REMOTE is set to ON).
QUICK POWER ON	CAMERA PHOTO	<p>Sets Quick Power On mode to ON or OFF. When Quick Power On mode is enabled, the camera will enter recording standby mode in CAMERA mode about 1.9 seconds after power is turned ON.</p> <p>ON OFF</p> <ul style="list-style-type: none"> • Startup time will not decrease even if an SD Memory Card is not inserted. • The zoom ratio will be set to approximately x 1 wide end (Z00).
HDMI OUT SEL	CAMERA PHOTO PB	<p>Sets the output video format of the HDMI OUT terminal.</p> <p>AUTO: Automatically determines the output resolution based on information of connected monitors.</p> <p>1080i/720P: Fix the output at the recorded resolution. (Output in 1080 interlaced or 720 progressive mode)</p> <p>480P: Output in 480 progressive mode.</p> <ul style="list-style-type: none"> • Simultaneous output from HDMI OUT, COMPONENT OUT, and A/V OUT is not possible. The order of priority is HDMI > COMPONENT > A/V.
COMPNT OUT SEL	CAMERA PHOTO PB	<p>Selects the type of component terminal.</p> <p>AUTO: Monitor with D4 terminal (720P/1080i output)</p> <p>1080i: Monitor with D3 terminal (1080i output)</p> <p>480i: Monitor with D1 terminal (480i output)</p> <ul style="list-style-type: none"> • Cross-conversion is only performed when content recorded at 720P is output at 1080i. Cross-conversion does not take place in other cases.
DOWNCON MODE	CAMERA PB*1	<p>Switches down-conversion output mode.</p> <p>SIDE CROP: Crops the left and right edges.</p> <ul style="list-style-type: none"> • Images may extend beyond the boundaries of the screen and be partially unable to be seen when outputting from the AV/OUT terminal, or when outputting from the COMPONENT OUT terminal when the COMPNT OUT SEL item is set to 480i. <p>LETTER BOX: Adds black bars to the top and bottom edges.</p> <p>SQUEEZE: Squeezes images horizontally from the left and right.</p>
VIDEO SETUP	CAMERA PB*1	<p>Sets the setup level of video signals.</p> <p>0%: AV/OUT terminal output and recording setup levels will both be set to 0%.</p> <p>7.5% A: AV/OUT terminal output setup level will be set to 7.5%, while recording setup level will be set to 0%.</p>
AUDIO OUT	CAMERA PB*1	<p>Sets the audio signals output from the A/V OUT terminal.</p> <p>CH1/CH2: CH1 terminal = CH1 signals, CH2 terminal = CH2 signals</p> <p>CH1: CH1 terminal = CH1 signals, CH2 terminal = CH1 signals</p> <p>CH2: CH1 terminal = CH2 signals, CH2 terminal = CH2 signals</p> <ul style="list-style-type: none"> • When an SD Memory Card containing 5.1 channel content, recorded on other equipment, is played back on the camera, it is down-mixed to 2 channels when output through the AV/OUT or headphone terminal.

*1 Only during clip playback

_____ indicates the factory setting.

OTHER FUNCTIONS screen (continued)

Item	Display mode	Description of settings
TV ASPECT	PHOTO PB*2	Sets the aspect ratio of the TV that will be connected. 16:9 4:3
MENU INIT	CAMERA PHOTO	Returns menu settings to factory default settings. YES <u>NO</u> • Returns all items except CLOCK SET, TIME ZONE, and OPERATION TIME to factory default settings.
SYSTEM INFO	CAMERA PHOTO PB	Displays the version of the system in this camera. YES <u>NO</u>
CALIBRATION	CAMERA PHOTO	Adjusts touch panel calibration. YES <u>NO</u> • Cannot be adjusted when the LCD monitor is rotated 180°.
LANGUAGE	CAMERA PHOTO PB	Selects the language for menu displays. English Français Español
OPERATION TIME	CAMERA PHOTO PB	Displays the power-on time (a 5-digit figure).

*2 Only during still image playback

___ indicates the factory setting.

Before calling for service

Power supply

There's no power.	<ul style="list-style-type: none"> • Make sure the battery and AC adapter are connected properly. Check the connections again. 	P23
Power shuts off for no apparent reason.	<ul style="list-style-type: none"> • To prevent the battery from running down needlessly, the camera-recorder automatically turns off when the camera-recorder has been left in the recording pause mode for more than 5 minutes. Check the settings in the OTHER FUNCTIONS screen, POWER SAVE. 	P110
Power goes off as soon as it is turned on.	<ul style="list-style-type: none"> • The battery may have run out. If the remaining battery charge display is blinking or  appears, the battery has run out. Either recharge the battery or replace the discharged battery with a fully charged one. 	P21

Battery

The battery runs down quickly.	<ul style="list-style-type: none"> • Make sure the battery is fully charged. Keep charging until the AC adapter's CHARGE lamp goes out. • Are you using the battery in a cold place? The battery is affected by the ambient temperature. Its operating time is reduced in low-temperatures. • The battery may have reached the end of its service life. The battery will become unchargeable. The battery has a certain service life which varies depending on how the battery is used. If the battery operates only for a short period even when it is charged adequately, it has reached the end of its service life. 	P21
The battery cannot be charged.	<ul style="list-style-type: none"> • The battery cannot be charged if the DC cable is connected. Disconnect it. 	P21
The remaining battery capacity is not displayed correctly.	<ul style="list-style-type: none"> • The remaining battery capacity display is merely a guideline. To ensure that remaining battery capacity is displayed correctly, use the battery completely from a fully-charged state, and charge the battery again. (Remaining battery capacity may still not be displayed correctly if the battery has been used for long periods in high or low temperatures, or if the battery has been recharged a large number of times.) 	—

Shooting

Cannot start shooting.	<ul style="list-style-type: none"> • Make sure the POWER switch is ON. 	P26
Cannot focus automatically.	<ul style="list-style-type: none"> • Make sure the camera is in manual focus mode. You can focus automatically when the auto focus mode is selected. • You may be shooting a scene where it is difficult to bring the subject into focus in the auto focus mode. If this is the case, focus in the manual focus mode. It may be hard to bring the subject into focus when <ul style="list-style-type: none"> · both close and distant objects are to be shot · shooting through a dirty window · shooting in a dark place · there are sparkling or shiny objects around the subject · the subject is moving fast · shooting a scene with minimal contrast 	P40
Images do not focus when zooming.	<ul style="list-style-type: none"> • When using a macro range for the focus control, the zoom is set to the wide end or the telephoto end, and even if the image is focused, zooming may cause the image to become unfocused. For details about the macro display, see page 89. 	—

Recording

Cannot record even through the SD Memory Card is inserted correctly.	<ul style="list-style-type: none"> Is the write-protect switch on the SD Memory Card in the "LOCK" position? The card cannot be recorded to if the switch is in the "LOCK" position. 	P37
	<ul style="list-style-type: none"> Is the remaining memory available on the SD Memory Card extremely low? Please save contents onto different media and delete unneeded data from the card, or use a new card instead. 	P35
	<ul style="list-style-type: none"> Has the SD Memory Card been correctly formatted? Alternatively, is the card of a format that is incompatible with this camera? Reformat the card with the camera. 8 MB – 16 MB SD Memory Cards cannot be used for video recording. 	P12
Recording stops by itself.	<ul style="list-style-type: none"> Is your SD Memory Card compatible with use for video recording? Always use an SD Memory Card compatible with use for video recording. 	P12

Editing

Cannot read the data on the SD Memory Card.	<ul style="list-style-type: none"> Make sure the SD Memory Card is formatted correctly. If it is not, format the card in the unit. 	P35
Cannot perform nonlinear editing.	<ul style="list-style-type: none"> Check the specifications of your computer and connecting cable. 	P85
Cannot dub onto an external device.	<ul style="list-style-type: none"> Make sure the external device is connected correctly. 	P83

Displays

Something is wrong with the time code display.	<ul style="list-style-type: none"> The time code display may not register a regular count if a clip is played in the reverse slow mode. This is normal. 	—
---	--	---

Playback

Cannot play even when I press the play button.	<ul style="list-style-type: none"> Make sure the PB lamp is on. Lower the POWER switch to turn the PB lamp on. 	P70
	<ul style="list-style-type: none"> Is the playback format correct? Make sure the playback format on the camera matches the recording format for the clip. 	P73
Mosaic-like noise appears when I cue or review a clip.	<ul style="list-style-type: none"> This noise is inherent to digital video technology. This is normal. 	—
Images do not appear on the television even though I have connected the camera-recorder properly.	<ul style="list-style-type: none"> Make sure the input selector on your television is set to video input. Read the television's instructions carefully and select the correct video input connector for the camera-recorder. 	—
Cannot hear any sound from the camera-recorder's speaker.	<ul style="list-style-type: none"> You may have turned down the camera-recorder's volume control too far. Adjust the volume using the + zoom button. 	P71

Before calling for service (continued)

PC connection

Computer does not recognize camera when USB connection cable is connected.	<ul style="list-style-type: none">• Check the operating environment.• If your computer has multiple USB terminals, please try connecting the camera to a different USB terminal.• Switch the camera's power off and back on again, and reconnect the USB connection cable.	P85
An error message appears on the computer when the USB connection cable is disconnected.	<ul style="list-style-type: none">• To disconnect the USB connection cable safely, double-click the icon in the task tray, and follow the instructions on the screen.	—

Other

The remote control does not work.	<ul style="list-style-type: none">• The battery in the remote control may have run out. If the remote control fails to work even if it is operated close to the remote control sensor of the camera-recorder, it means that the battery has run out. Replace it with new one.• Is the IR REMOTE item on the setting menu OTHER FUNCTIONS screen set to OFF?	P26
There is a rattling sound when the camera-recorder is tilted back and forth.	<ul style="list-style-type: none">• This is the sound of the lens moving. This is not a fault. No sound should be heard when the camera's power is switched on.	—
A clicking sound is heard when the power is turned on or when the PB mode is switched to the CAM mode.	<ul style="list-style-type: none">• This initialization operation is performed when the camera starts up. It occurs due to the construction of the camera and is not indicative of any trouble.	—
The SD Memory Card screen appears strange.	<ul style="list-style-type: none">• The data on the card could be corrupted. Data can be corrupted by static electricity and electromagnetic waves. Please always save important data to a computer or other storage media.	—
The SD Memory Card cannot be used even after formatting.	<ul style="list-style-type: none">• There could be a fault with the camera or with the SD Memory Card. Please consult the place of purchase. Always use only SD Memory Cards of 512 MB - 32 GB with this camera.	—
The camera does not recognize the SD Memory Card even though it is inserted correctly.	<ul style="list-style-type: none">• Was the inserted SD Memory Card originally formatted with a computer? Always use this camera to format SD Memory Cards. Please be aware that, when an SD Memory Card is formatted, all data recorded on the card will be erased and will not be restorable.	P35
The SD Memory Card is not recognized when inserted into other devices.	<ul style="list-style-type: none">• Please check that the device is compatible with the capacity or type (SD Memory Card/SDHC Memory Card) of the SD Memory Card that you are using. For details, please consult the device's own operating instructions.	P13

The changeover between clips may not always be smooth when playing back multiple clips in succession. Video may momentarily pause when playing back multiple clips in succession in circumstances such as those detailed below.

■ **Mixture of different recording formats**

Recording mode = PH mode
 Playback format = 1080/60i(30P)

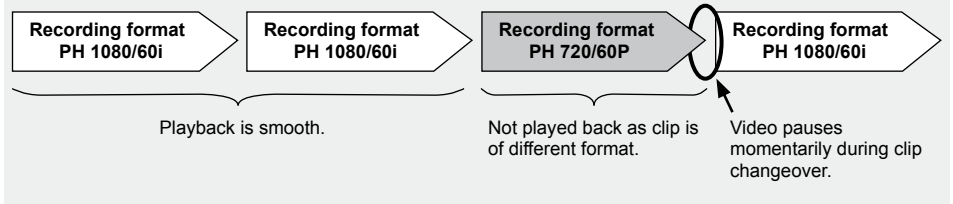

■ **Mixture of different recording modes**

Recording format = 1080/60i
 Playback format = 1080/60i(30P)

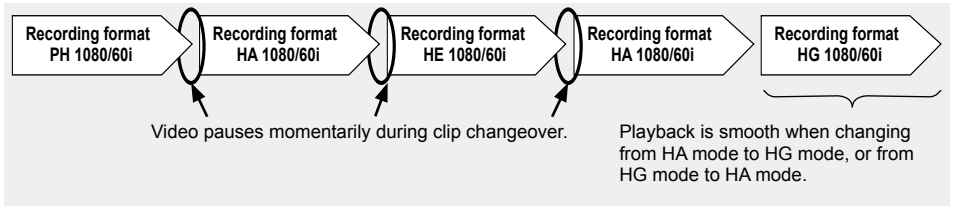

■ **Some clips have been recorded using PRE REC function**

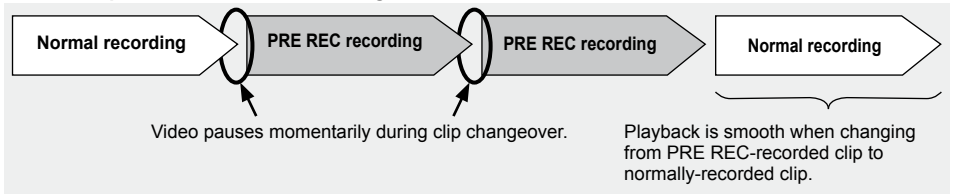

■ **Some clips have a recording time of less than 3 seconds**

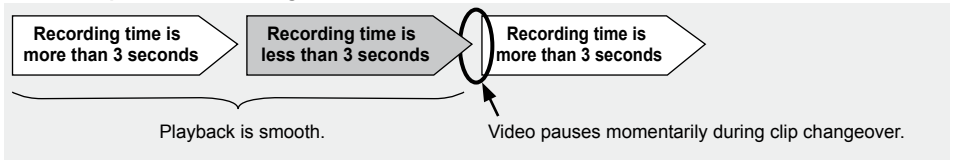

Updating the firmware

For the latest information on firmware updates, visit the support page at the following Web site.

<https://www.pavc.panasonic.co.jp/pro-av/>

Cleaning

When cleaning, do not use benzene or thinner.

- Using benzine or paint thinners may deform the camera-recorder and/or cause the surface finish to peel off.
- Before proceeding with maintenance, remove the battery or disconnect the AC cable from the power outlet.
- Use a soft, clean cloth to wipe the camera-recorder. To remove stubborn dirt, wipe the camera-recorder with a cloth moistened with kitchen detergent that has been diluted with water and then use a dry cloth to take up the remaining moisture.

Storage Precautions

Before storing the camera-recorder, remove both the SD Memory Card and battery. Store all of these items in a place with low humidity and relatively constant temperature.

[Recommended temperature range: 15°C to 25°C (59 °F to 77 °F)]

[Recommended relative humidity: 40% to 60%]

Camera-recorder

- Wrap the camera-recorder in a soft cloth to keep the dust off.

Battery

- The battery life is shortened in places with extreme temperatures.
- Storing the battery in a location with oily vapors or high dust concentrations may corrode the terminals or cause other damage, leading to malfunction.
- **Keep metal objects (such as necklaces and hairpins) away from the terminals. Short-circuiting may occur across the terminals, causing the battery to heat up, and you may seriously burn yourself if you touch the battery in this state.**

SD Memory Cards

- After ejecting an SD Memory Card from the unit, be absolutely sure to stow it in its own case.
- Do not leave SD Memory Cards in areas where corrosive gases, etc. are present.
- Do not leave the cards inside vehicles, in places exposed to direct sunlight or in other places where the temperature is high.
- Do not leave the cards where the humidity level is high or where there are high concentrations of dust.

Recording format

Recording mode		Frame rate		
		60	30P	24P
PH	1080/60i	1080/60i	1080/30P (over 60i)	1080/24P (Native recording)
	720/60P	720/60P	720/30P (over 60P)	720/24P (Native recording)
HA	1080/60i	1080/60i	–	–
HG	1080/60i	1080/60i	–	–
HE	1080/60i	1080/60i	–	–

How to handle data recorded on SD Memory Card

Data recorded in AVCHD format offers excellent compatibility with computers due to the file type, but since this format includes not only video and audio data, but also a variety of important information, the folder structure will consist of file associations as illustrated in the diagram on the right. If even part of this information is modified or deleted, the data may no longer be recognized as AVCHD data, or the memory card may not longer be able to be used with AVCHD devices.

To prevent the loss of any part of the information when transferring data on the SD Memory Card to a computer or when copying data stored on a computer back onto the SD Memory Card, be sure to use the dedicated AVCCAM Viewer. The AVCCAM Viewer can be downloaded from the following website.

Both a Windows version and a Mac version are available.

(Compatible OS: Windows XP/Windows Vista/Mac OS 10.5.1/ Mac OS 10.5.2)

<https://www.pavc.panasonic.co.jp/pro-av/>

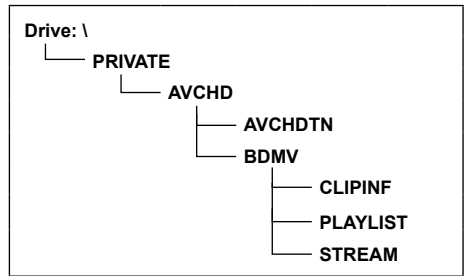

■ Concerning the handling of the camera's metadata

A special manufacturer area in the control file area under the AVCHD standard is employed for the metadata which is supported by this camera.

If files are deleted or copied, if clip protection is added or removed or if other such editing operations have been performed using editing software or a camera recorder which does not support this camera's metadata, the special area for the metadata will be erased, and the shot marks added by the camera as well as the PH mode information and other information will be lost. Therefore, before proceeding with these kinds of editing operations, check whether the camera's metadata is supported.

Specifications

[General]

Supply voltage:DC 7.2 V

(when the battery is used)

DC 7.3 V

(when the AC adapter is used)

Power consumption:

7.8 W (MAX) : When XLR Microphone Adapter (AG-MYA30G) is connected

5.8 W : During stand-alone use

indicates safety information.

Ambient operating temperature

0 °C to 40 °C (32 °F to 104 °F)

Ambient operating humidity

10% to 80% (no condensation)

Weight

Approx. 980 g (2.16 lb)

(excluding battery and accessories)

Dimensions (W x H x D)

136 mm × 135 mm × 304 mm

(5-11/32 inches × 5-5/16 inches × 11-31/32 inches)

(excluding the projection part)

[Camera]

Pickup devices

1/4.1-inch MOS solid-state image sensor × 3

Total pixels

Approx. 3.05 million pixels × 3

Effective pixels (video)

Approx. 2.51 million pixels × 3 (16:9)

Effective pixels (still image)

Approx. 2.32 million pixels × 3 (4:3),

Approx. 2.65 million pixels × 3 (3:2),

Approx. 2.51 million pixels × 3 (16:9)

Lens

LEICA DICOMAR Optical image stabilizer lens,

Motorized 12 x zoom,

F1.8 to 2.8 (f=4.0 mm to 48 mm)

35 mm equivalent (video):

40.8 mm to 490 mm (16:9)

35 mm equivalent (still image):

41.3 mm to 496 mm (3:2),

40.8 mm to 490 mm (16:9),

45.0 mm to 540 mm (4:3)

Color separation optical system

Prism system

Filter diameter

43 mm

ND filter

Automatic ON/OFF interlock with iris

Closest shooting distance

0.9 m

Gain settings

Video recording: 0 to +24 dB (variable in 1 dB steps, up to +34 dB when HIGH GAIN is assigned to a USER button)

Still image recording: 0 to +18 dB (variable in 1 dB steps)

Shutter speed settings

CAMERA mode:

Preset

60i/60P mode:

1/60, 1/100, 1/120, 1/250, 1/500, 1/1000,
1/2000 seconds

30P mode:

1/30, 1/50, 1/60, 1/120, 1/250, 1/500,
1/1000, 1/2000 seconds

24P mode:

1/24, 1/50, 1/60, 1/120, 1/250, 1/500,
1/1000, 1/2000 seconds

Synchronous scan settings:

60i/60P mode: 1/60.0 seconds to 1/250.0 seconds

30P mode: 1/30.0 seconds to 1/250.0 seconds

24P mode: 1/24.0 seconds to 1/250.0 seconds

Slow shutter speed settings:

60i/60P mode: 1/2, 1/4, 1/8, 1/15, 1/30 seconds

30P mode: 1/2, 1/4, 1/8, 1/15 seconds

24P mode: 1/2, 1/3, 1/6, 1/12 seconds

PHOTO mode:

1/2, 1/4, 1/8, 1/15, 1/30, 1/60, 1/100, 1/120,

1/180, 1/250, 1/350, 1/500, 1/750, 1/1000,

1/1500, 1/2000 seconds

Minimum subject luminance

Approx. 1 lx (with slow shutter speed of 1/2, and +34 dB gain)

Digital zoom

2 x /5 x /10 x (Assigned to the USER button, for switching zoom levels)

Operation with the 1080/60i and 720/60P formats only

Lens hood

Large-sized lens hood with wide angle of view

[Recording/playback (video)]

Recording Format

AVCHD specifications

Compression method

MPEG-4 AVC/H.264

Recording media

SD Memory Card:

512 MB, 1 GB, 2 GB (FAT12 and FAT16 format)

SDHC Memory Card:

4 GB, 6 GB, 8 GB, 12 GB, 16 GB, 32 GB
(FAT32 format)

SD/SDHC Memory Cards with a memory size from 8 MB to 32 GB can be used to read metadata.

Recording format (Recording mode: resolution)

PH mode:

1080/60i

1080/30P (over 60i)

1080/24P (Native recording)

720/60P

720/30P (over 60P)

720/24P (Native recording)

HA mode:

1080/60i

HG mode:

1080/60i

HE mode:

1080/60i

Transmission rate

PH mode: Approx. 21 Mbps (VBR)
HA mode: Approx. 17 Mbps (VBR)
HG mode: Approx. 13 Mbps (VBR)
HE mode: Approx. 6 Mbps (VBR)

[Recording/playback (still image)]

Compression method

JPEG (DCF/Exif 2.2-compliant),
DPOF-compatible

Recording media

SD Memory Card:
8 MB, 16 MB, 32 MB, 64 MB, 128 MB,
512 MB, 1 GB, 2 GB
(FAT12 and FAT16 format)
SDHC Memory Card:
4 GB, 6 GB, 8 GB, 12 GB, 16 GB, 32 GB
(FAT32 format)

Recording pixels

Aspect ratio [4:3]:
3520×2640 pixels, 3264×2448 pixels,
2560×1920 pixels, 640×480 pixels
Aspect ratio [3:2]:
3984×2656 pixels, 3264×2176 pixels,
2592×1728 pixels
Aspect ratio [16:9]:
4224×2376 pixels, 3328×1872 pixels,
2560×1440 pixels

[Video System]

Video signals

1080/60i, 720/60p

Video output

HDMI output
HDMI (Type A connector)×1
1080/60i, 720/60p, 480/60p
(Not compatible with VIERA Link)
Analog component output
Mini D terminal × 1
Y: 1.0 V [P-P], 75 Ω
P_B/P_R: 0.7 V [P-P], 75 Ω
A/V OUT terminal video output × 1
1.0 V [P-P], 75 Ω

[Audio System]

Compression method

Recording/playback: Dolby Digital/2 ch

Sampling frequency

48 kHz

Encoding

16 bit

Compressed bit-rate

PH mode: 384 kbps
HA/HG/HE mode: 256 kbps

[Audio IN/OUT]

XLR adapter

Dedicated mini jack

AUDIO output

A/V OUT terminal audio output, 2ch
Output: 316 mV, 600 Ω

Internal microphone

Stereo microphone

External microphone input

-70 dBV (Mic sensitivity: -50 dB equivalent,
0 dB=1 V/Pa 1 kHz)
Stereo mini jack (3.5 mm diameter)
(Not compatible with plug-in power microphone)

HDMI

2 ch (Linear PCM), 5.1 ch (Dolby Digital)

Headphone

Stereo mini jack (3.5 mm diameter) × 1

Internal speaker

20 mm (round) × 1

[Other inputs/outputs]

USB

Card reader/writer function
(no copyright protection support)
USB Type mini B connector
USB 2.0-compliant, PictBridge-compatible

CAM REMOTE

Super mini jack (2.5 mm diameter) (ZOOM S/S)
Mini jack (3.5 mm diameter) (FOCUS, IRIS)

[Monitor]

LCD monitor

2.7-inch wide-type LCD color monitor
(approx. 230,000 pixels)

Viewfinder

0.26-inch wide-type LCD EVF
(approx. 113,000 pixels)

[AC adapter]

Power Source:	110 V - 240 V AC, 50 Hz/60 Hz 22 W
Power Output:	7.3 V DC, 1.75 A (Camera-recorder) 8.4 V DC, 1.3 A (Charge)

 indicates safety information.

Weight

140 g (0.31 lb)

Dimensions (W x H x D)

103 mm × 36 mm × 62 mm
(4-1/16 inches × 1-13/32 inches × 2-7/16 inches)

Weight and dimensions are approximate.
Specifications are subject to change without notice.

Information on Disposal in other Countries outside the European Union



This symbol is only valid in the European Union.
If you wish to discard this product, please contact your local authorities or dealer and ask for the correct method of disposal.



Panasonic Broadcast & Television Systems Company Unit Company of Panasonic Corporation of North America

Executive Office: One Panasonic Way 4E-7, Secaucus, NJ 07094 Tel: 201-348-7000

Eastern Zone: One Panasonic Way 4E-7, Secaucus, NJ 07094 Tel: 201-348-7196

Southeast Region: Tel: 201-392-6151

Western Zone: 3330 Cahuenga Blvd W., Los Angeles, CA 90068 Tel: 323-436-3608

Government Marketing Department:

One Panasonic Way 2E-10, Secaucus, NJ 07094 Tel: 201-348-7587

Broadcast PARTS INFORMATION & ORDERING:

9:00 a.m. – 5:00 p.m. (EST) Tel: 800-334-4881/24 Hr. Fax: 800-334-4880

Emergency after hour parts orders Tel: 800-334-4881

e-mail: PBTSparts@us.panasonic.com

TECHNICAL SUPPORT: Emergency 24 Hour Service Tel: 800-222-0741

e-mail: PBTSCservice@us.panasonic.com

Panasonic Canada Inc.

5770 Ambler Drive, Mississauga, Ontario L4W 2T3 Tel: 905-624-5010

Panasonic de México S.A. De C.V.

Casa Matriz: Moras No.313 Col. Tlacoquemecatl Del Valle Del.Benito Juárez México, D.F., C.P.03200

Tel: 55-5488-1000 Fax: 55-5575-6783

Panasonic Latin America, S.A.

P.O.Box 0816-03164 Panama, Republic of Panama Tel: +507-229-2955 Fax: 507-229-5352

Panasonic do Brasil Ltda.

Rua Cubatão, 320-6º andar-Paraíso CEP 04013-001- São Paulo -SP Tel: 11-3889-4000 Fax: 11-3889-4004